

# Word Puzzles & Games



## **This Home Workbook belongs to:**

---

**Use the incentive  
chart on the inside  
back cover to track  
your child's progress**

You can also:

- Place a sticker on each completed page.
- Place a sticker on each page when your child meets a time-based or other predetermined goal.





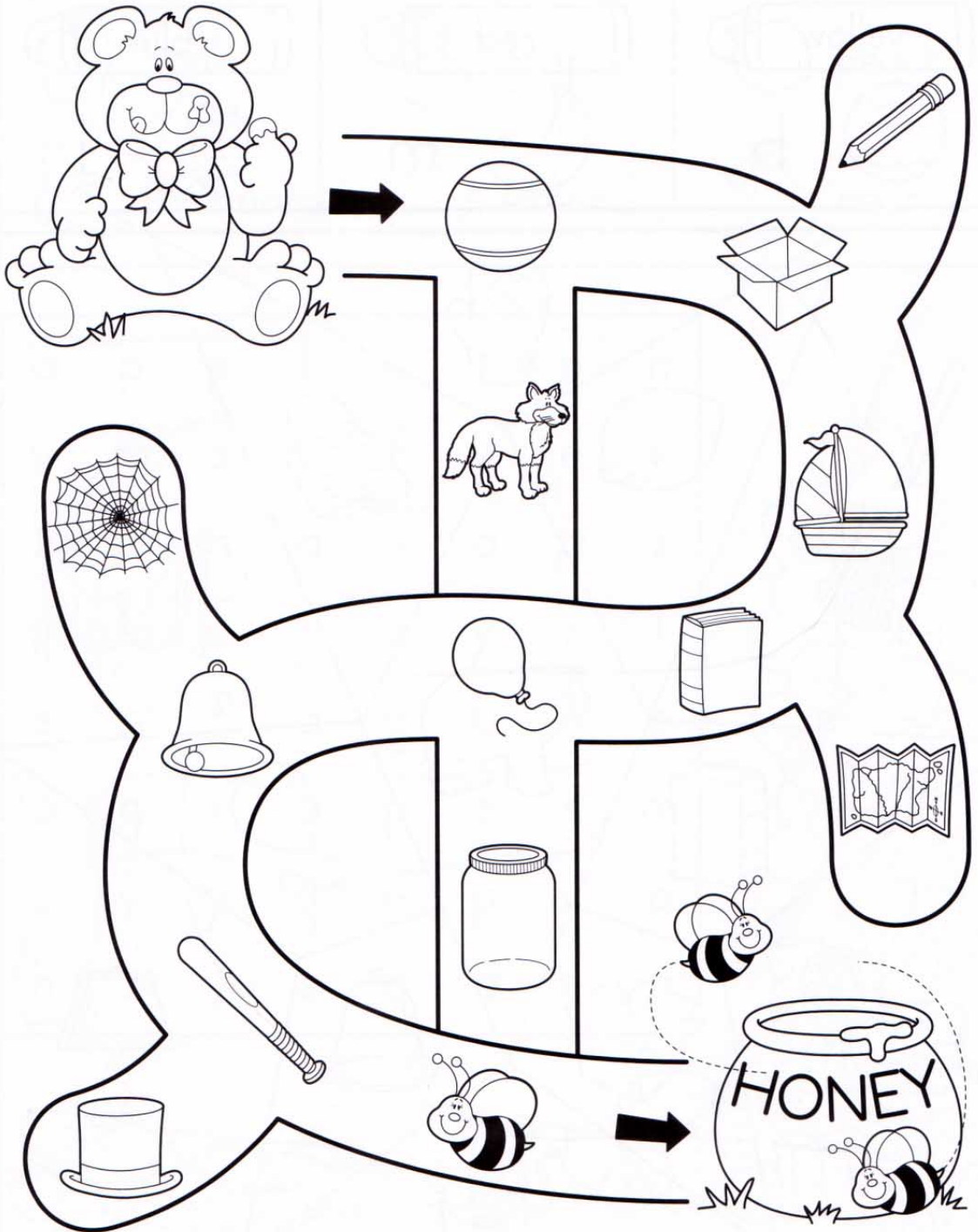

Draw a line along the path with pictures whose names **begin** with the **b** sound to help the bear find the honey.



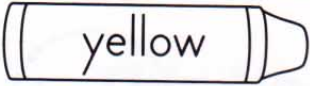
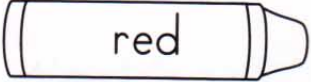
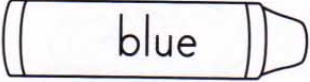

Use the key to color the spaces with pictures whose names **begin** with the same letter sounds.

 yellow	 red	 blue
 b	 m	 l

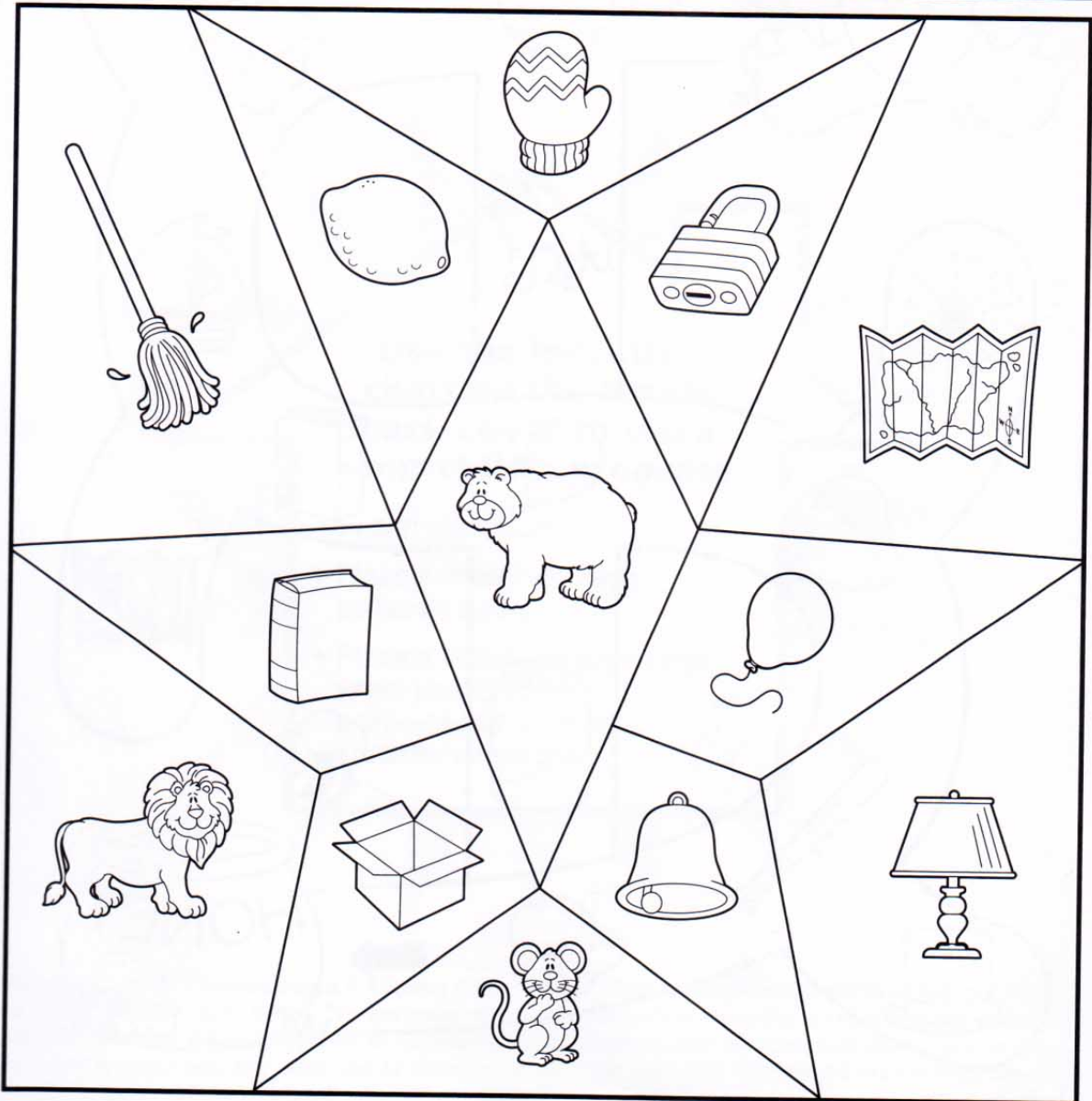

The puzzle consists of 10 triangular pieces arranged in a star shape. The pieces contain the following illustrations:

- Top: Mitten
- Top-left: Broom
- Top-middle: Lemon
- Top-right: Padlock
- Middle-right: Map
- Center: Bear
- Middle-left: Book
- Bottom-right: Balloon
- Bottom-middle: Bell
- Bottom: Mouse
- Bottom-left: Lion
- Bottom-middle-left: Box



Circle the words from the word box in the puzzle below.



apple



grapes



peach



banana



lemon



pear

a	p	p	l	e	j	p	h
y	m	s	v	f	v	e	v
b	a	n	a	n	a	a	z
p	u	s	j	z	y	r	l
e	n	f	a	g	b	n	e
a	g	r	a	p	e	s	m
c	y	y	g	e	p	v	o
h	z	y	s	q	d	e	n

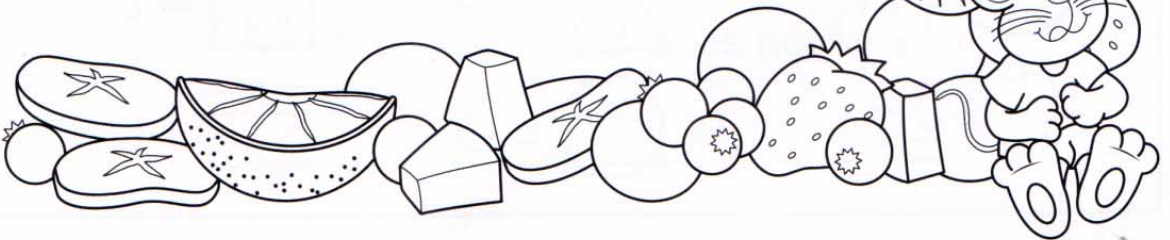
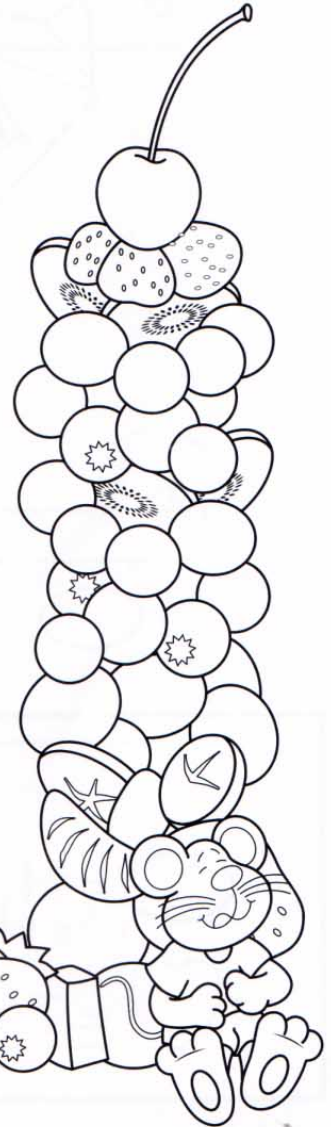

Use the secret code to solve the riddle.

Where do owls stay when they go on a trip?

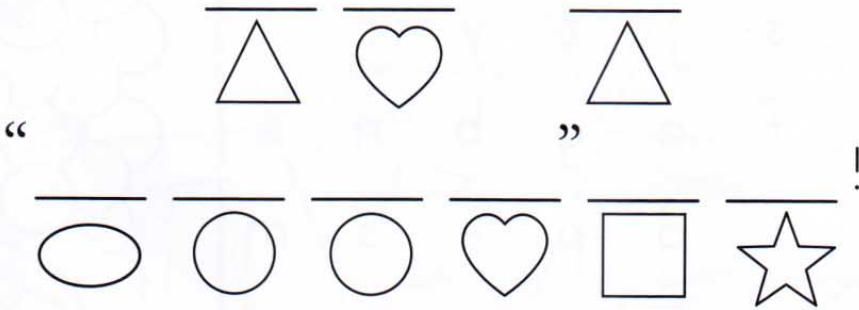
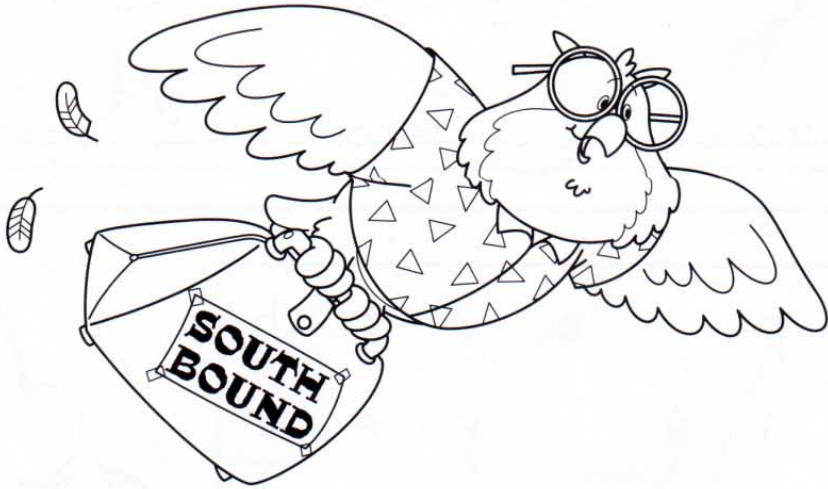

### Secret Code

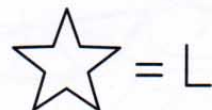
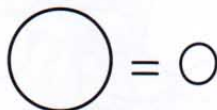
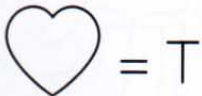
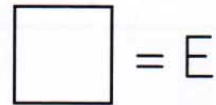
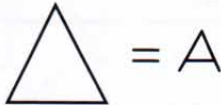
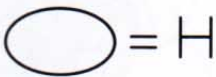

Unscramble each word and write it on the lines. Then, write the circled letters in order to answer the riddle.



t c a

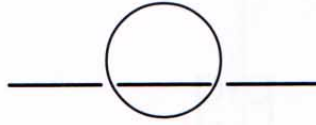

o a c t

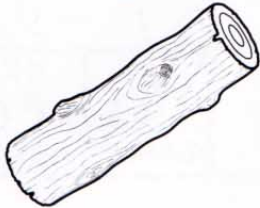
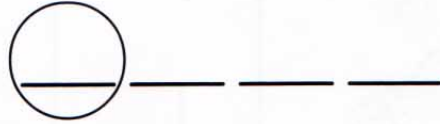

g o l

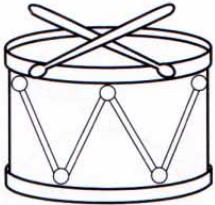
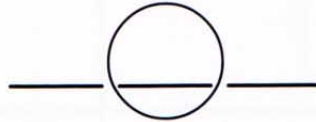

r d u m

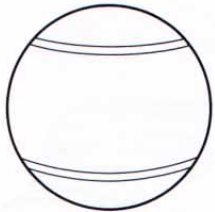
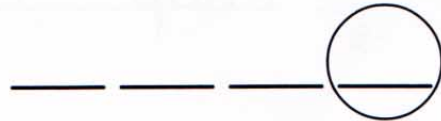

a l l b



What has teeth but does not bite?

\_\_\_\_\_



Draw lines to match the words with the same **short vowel** sound. Circle the picture that is left. It is the answer to the riddle: What has four legs but only one foot?

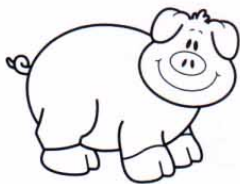

pig

cap

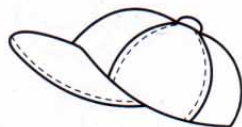

crab

frog

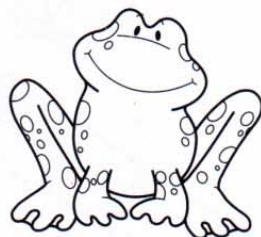

mop

hill

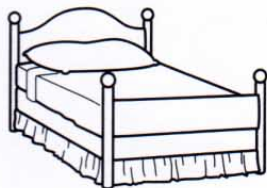
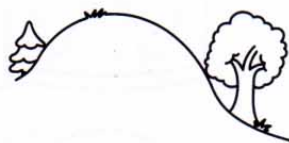

bed

bug

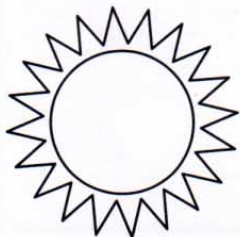
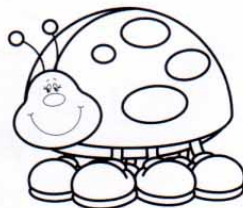

sun

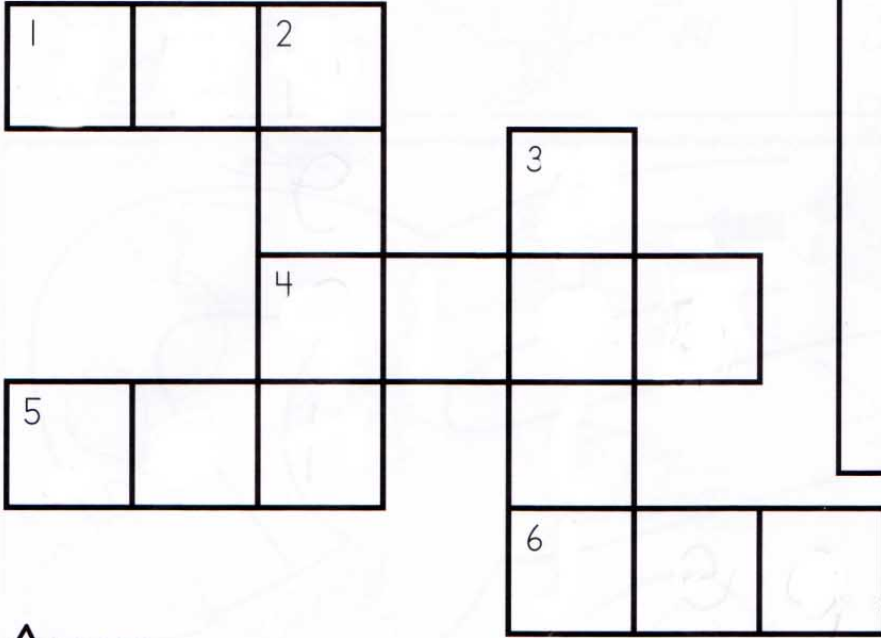

Use the words from the word list to solve the crossword puzzle.



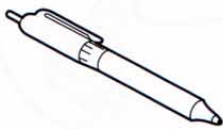
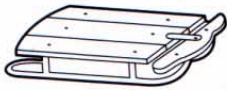

**Word List**

- bell
- jet
- leg
- nest
- pen
- sled

**Across**

- 1. 
- 4. 
- 5. 
- 6. 

**Down**

- 2. 
- 3. 

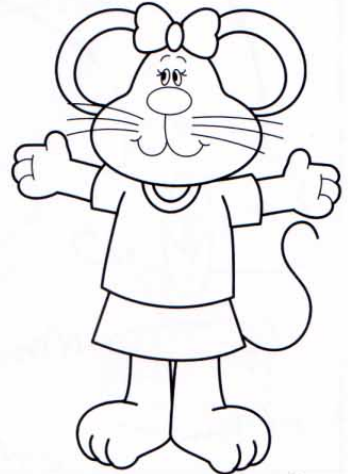

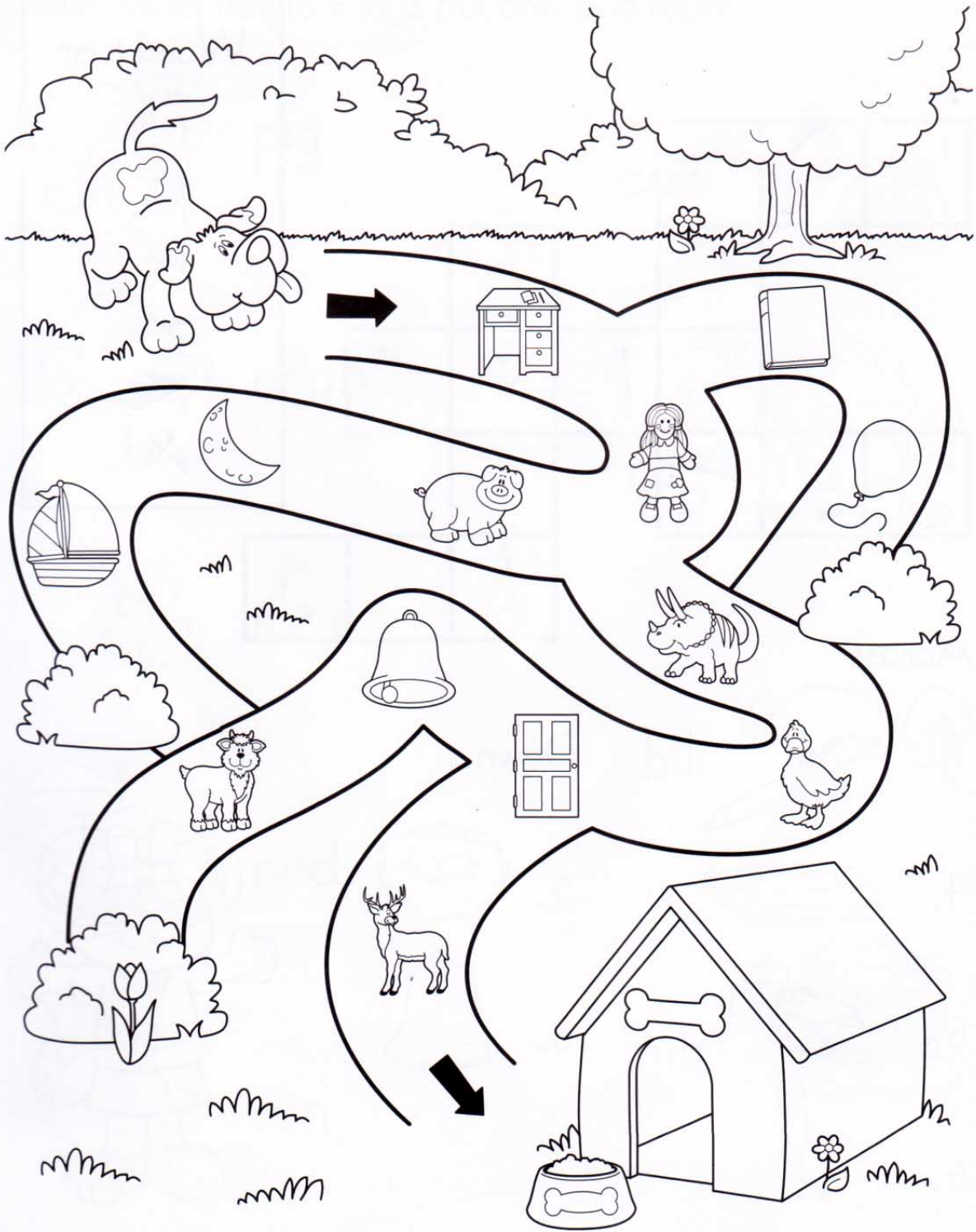

Draw a line along the path with pictures whose names **begin** with the **d** sound to help the dog find the doghouse.





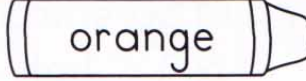
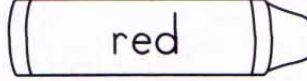

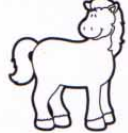

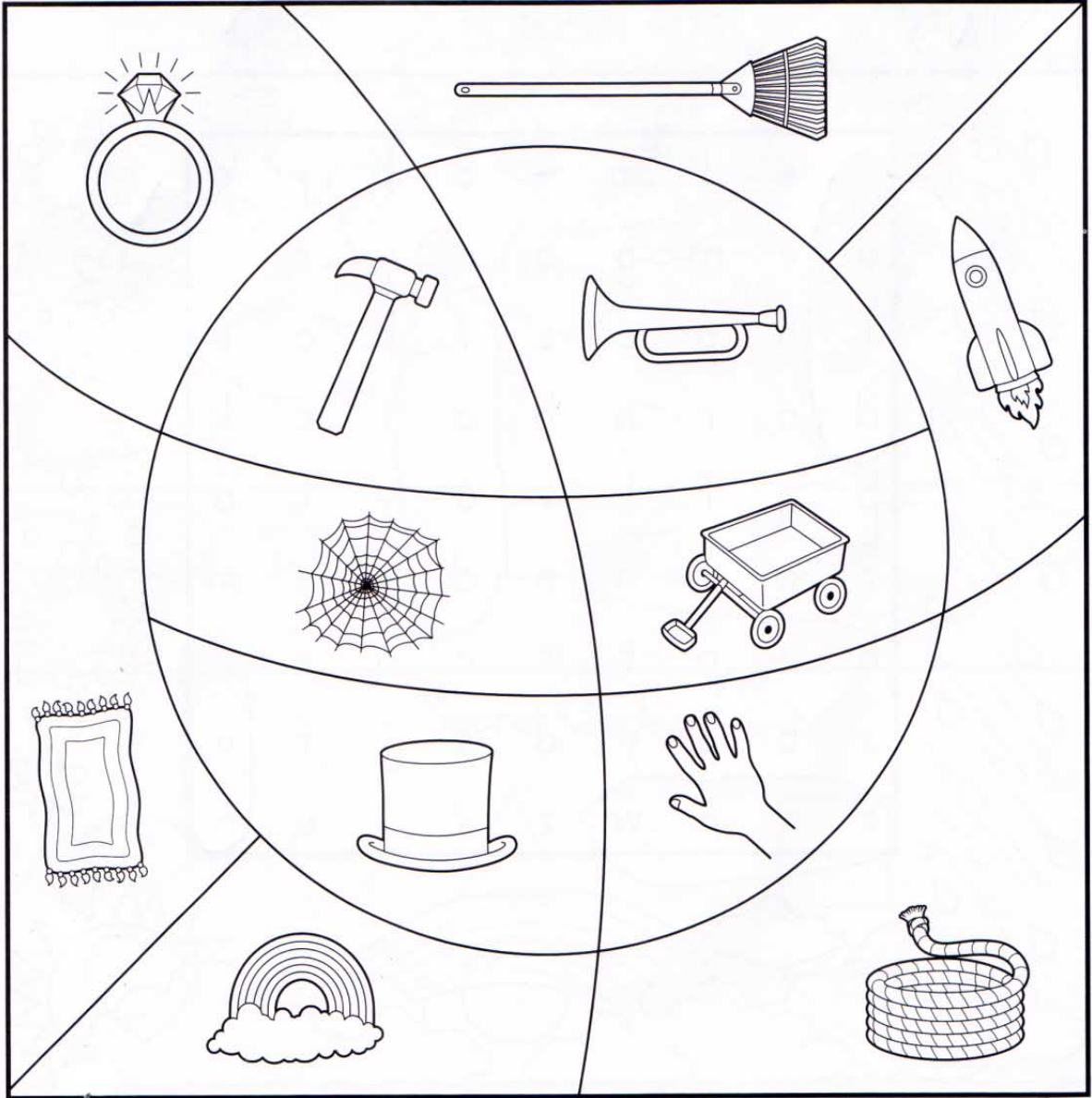



Use the key to color the spaces with pictures whose names **begin** with the same letter sounds.

 yellow	 orange	 red
 r	 w	 h



Circle the words from the word box in the puzzle below.

	cloud		hot		snow
	cold		rain		sun

	c	e	l	m	v	o	b	j	s	
	o	v	m	g	o	c	y	r	c	
	l	h	p	e	z	l	h	o	t	
	d	o	r	n	b	o	i	o	k	
	b	q	f	k	v	u	y	f	g	
	r	a	i	n	n	d	y	z	m	
	h	v	n	t	s	r	q	r	s	
	x	b	p	y	o	s	j	f	u	
	s	n	o	w	z	x	l	e	n	

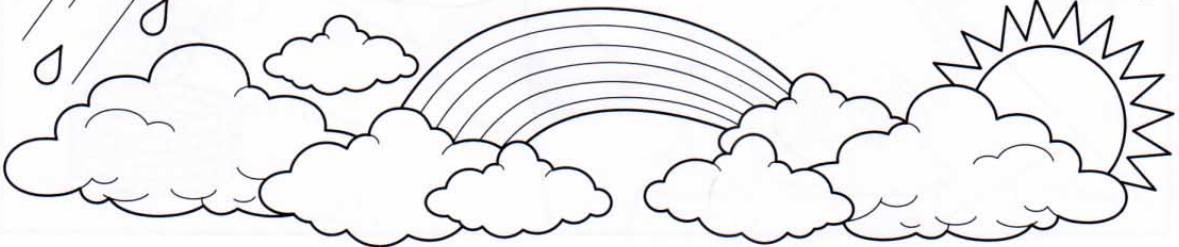

Use the secret code to solve the riddle.

What game do bunnies like?

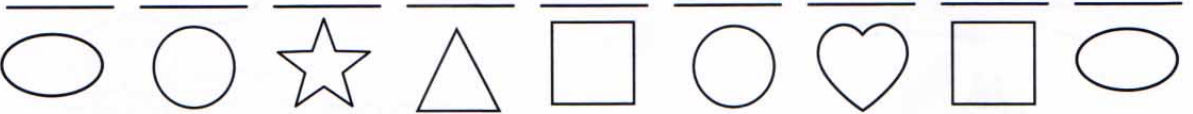
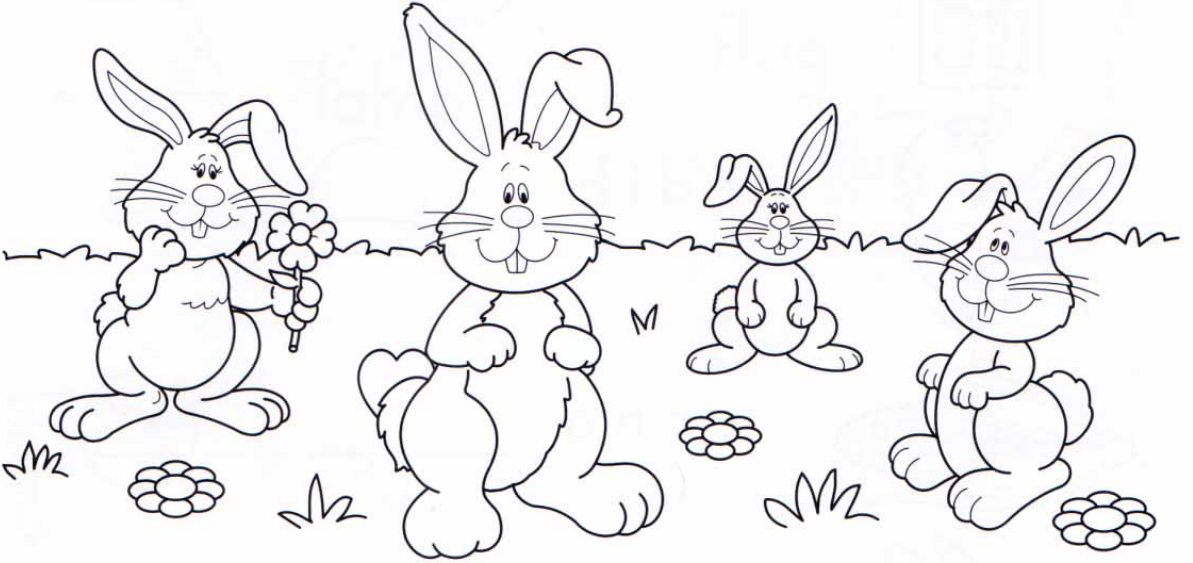

Secret Code

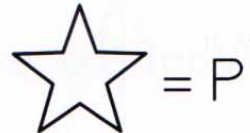
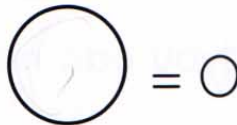
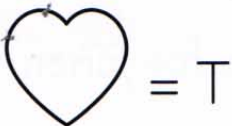
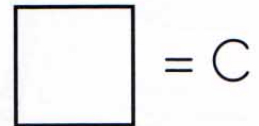
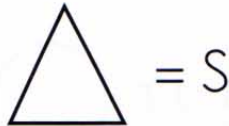
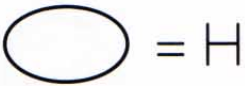



Unscramble each word and write it on the lines. Then, write the circled letters in order to answer the riddle.

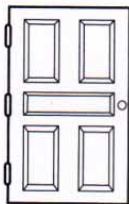

r o o d    o    \_ \_ \_



r d i b    \_ i \_ \_

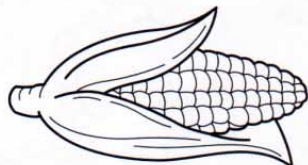

c r n o    \_ \_ \_ o



d a h n    \_ \_ \_ n



l u g e    \_ \_ \_ e

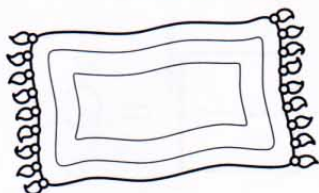

g u r    u    \_ \_

What is one thing you can never have for lunch?

\_\_\_\_\_

Draw lines to match the words with the same **ending** sound. Circle the picture that is left. It is the answer to the riddle: What goes up when rain comes down?

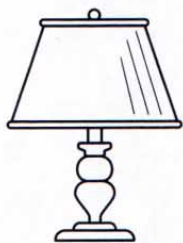

lamp

flag

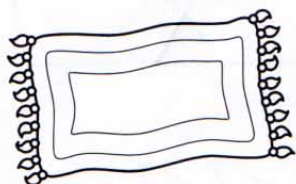
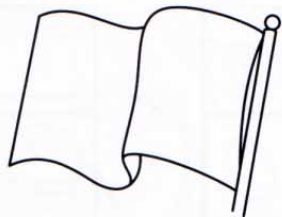

rug

bell



coat

jeep



umbrella



girl

tent

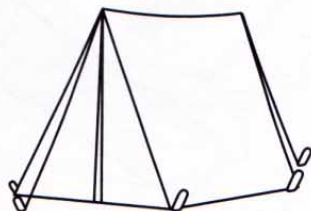



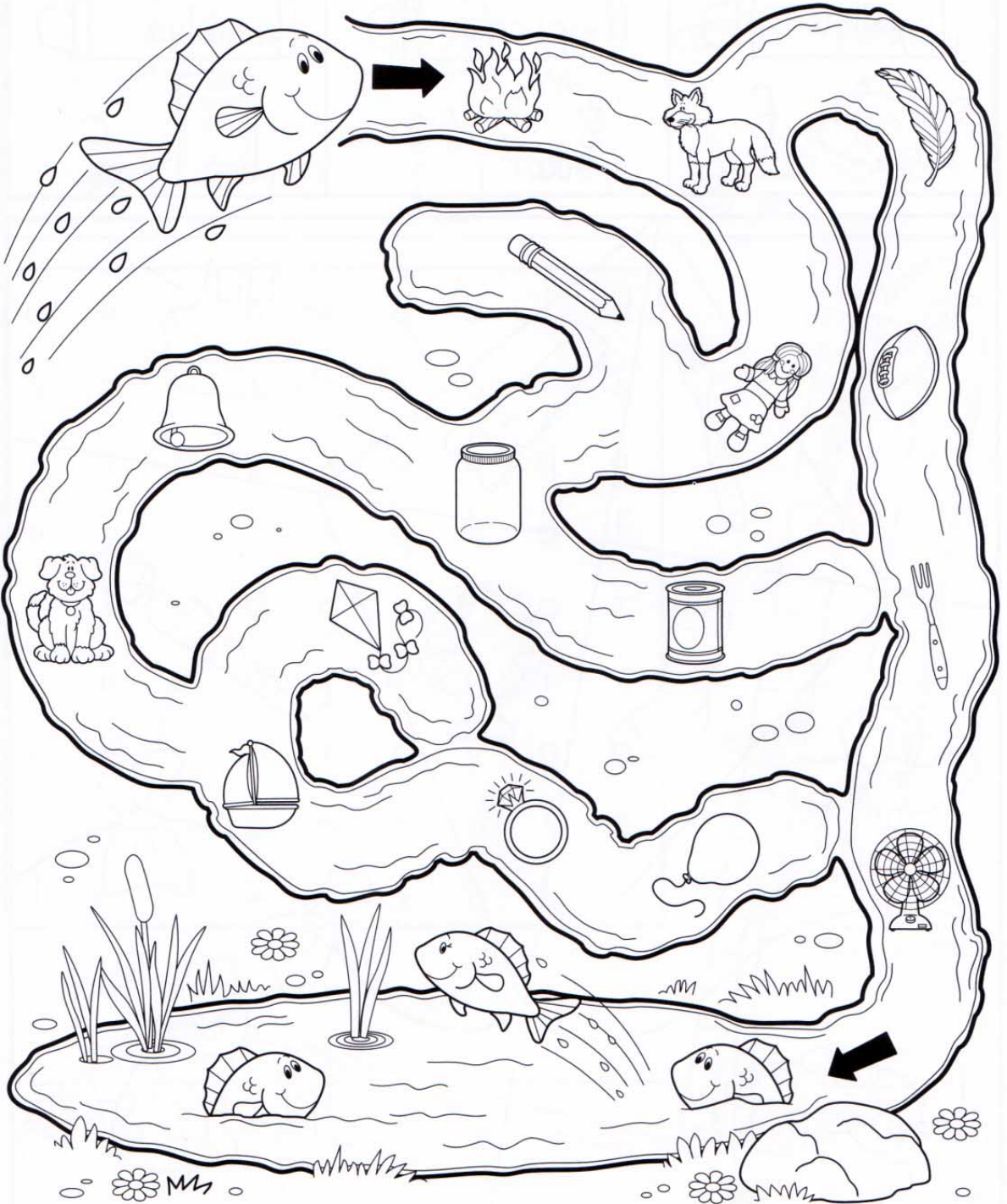

Draw a line along the path with pictures whose names **begin** with the **f** sound to help the fish find the pond.



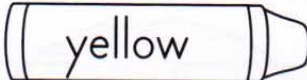
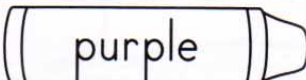

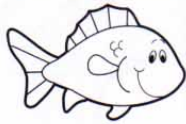
Use the key to color the spaces with pictures whose names **begin** with the same letter sounds.

 yellow	 purple	 blue
 f	 s	 c

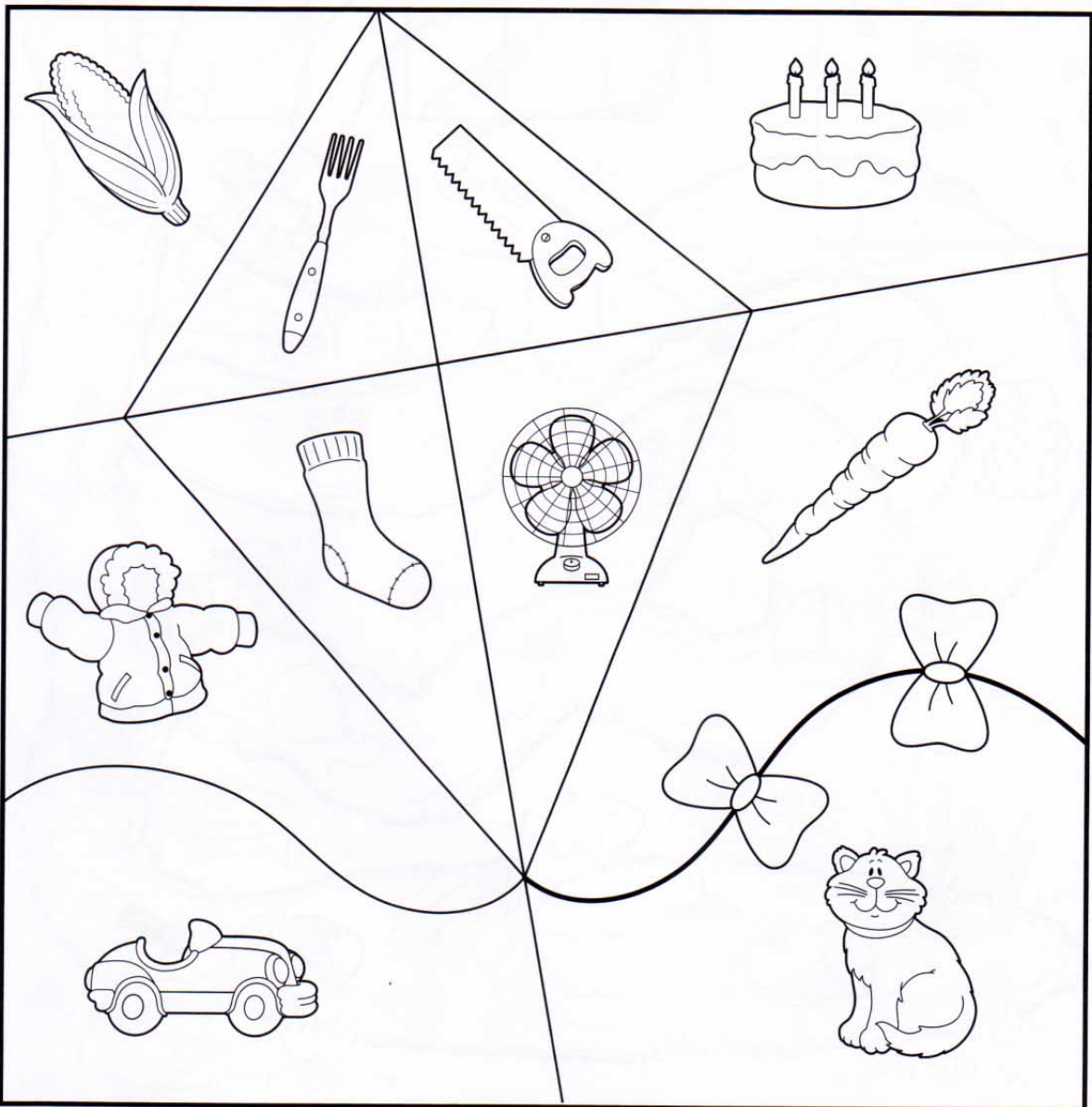

The large area is divided into several irregular shapes. Each shape contains a line drawing of an object:

- Top-left: Corn
- Top-middle-left: Fork
- Top-middle-right: Saw
- Top-right: Birthday cake
- Middle-left: Winter jacket
- Middle: Sock
- Middle-right: Fan
- Bottom-right: Carrot
- Bottom-right: Bow
- Bottom-left: Toy car
- Bottom-right: Cat

Circle the words from the word box in the puzzle below.

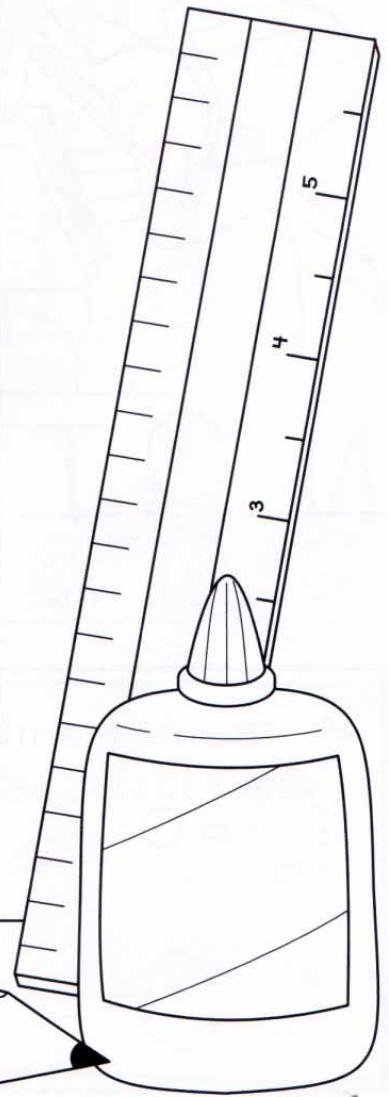
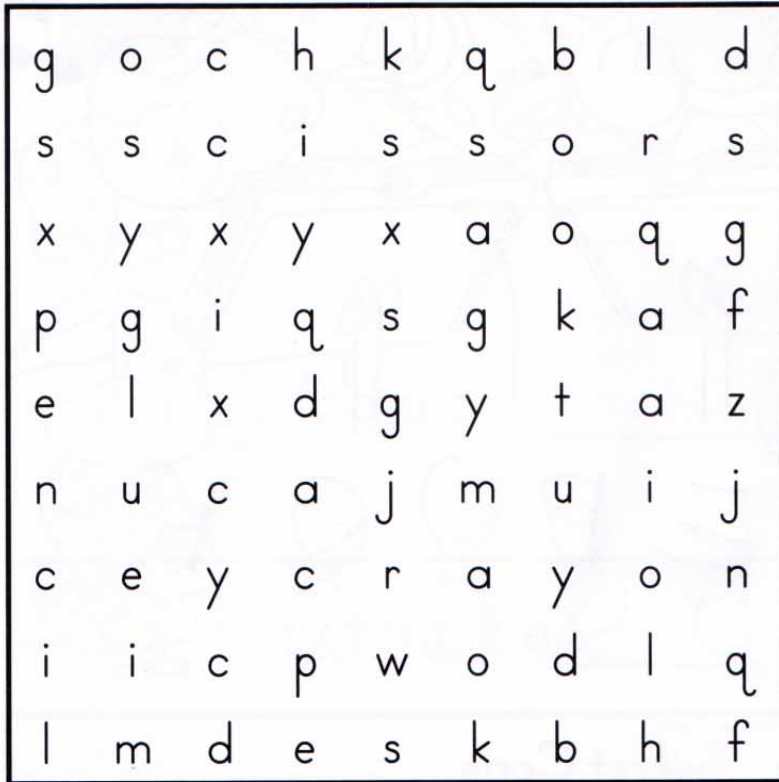

Use the secret code to solve the riddle.

What kind of books do musicians read?

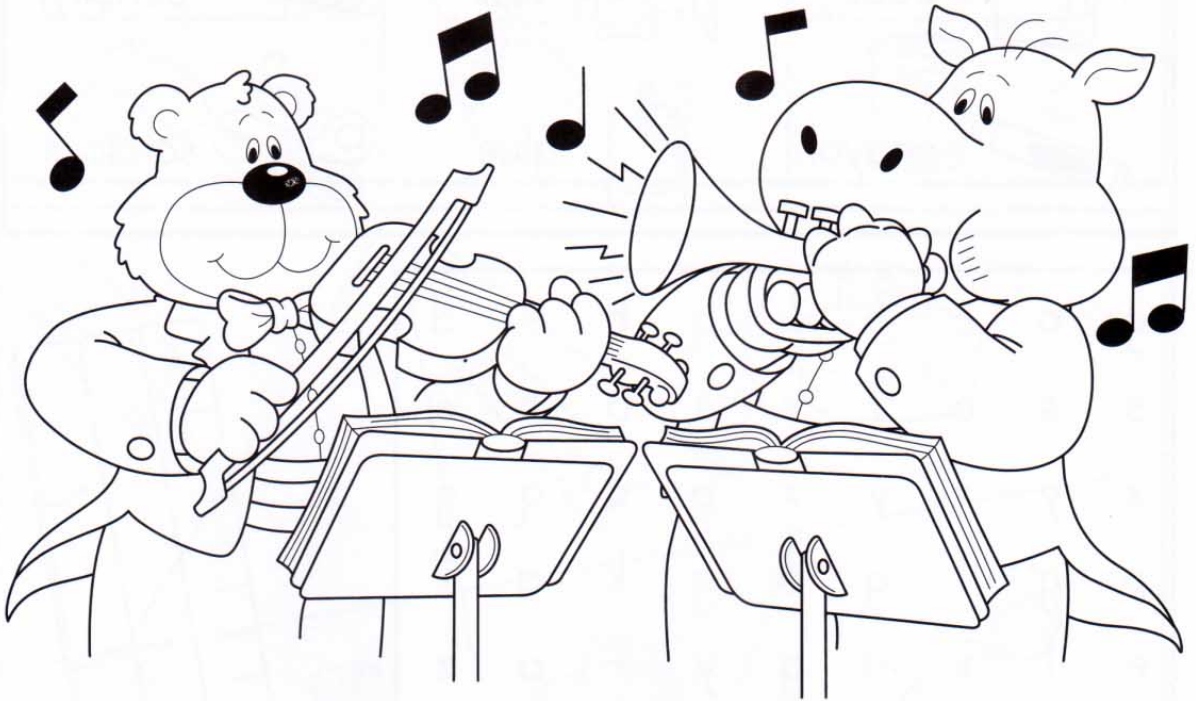

### Secret Code

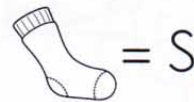
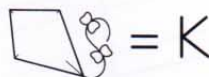
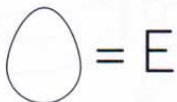
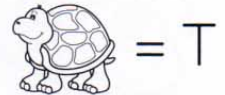
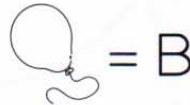
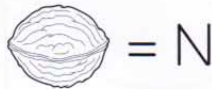
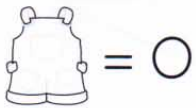

Unscramble each animal name and write it on the lines.  
Write the circled letters in order to find the secret word.



w c o  \_\_\_\_\_

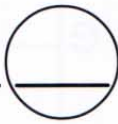

p e e s h \_\_\_\_\_  \_\_\_\_\_

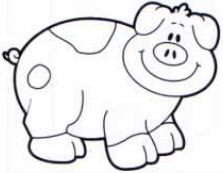

g i p \_\_\_\_\_  \_\_\_\_\_

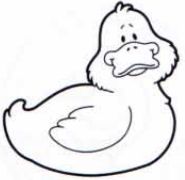

k d u c \_\_\_\_\_  \_\_\_\_\_

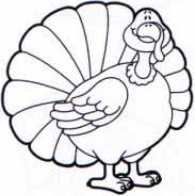

y t u r k e \_\_\_\_\_  \_\_\_\_\_

Secret Word

\_\_\_\_\_

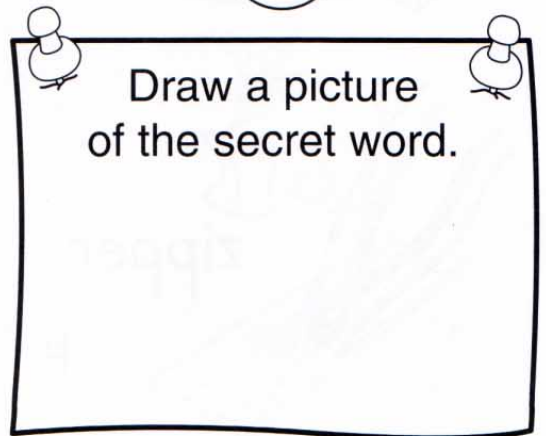



Draw lines to match the words with the same **beginning** sound. Circle the picture that is left. It is the answer to the riddle: What has a head and a tail, but no body?

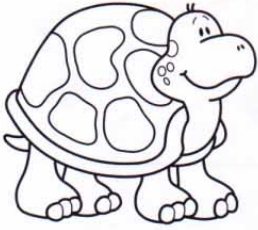

turtle

table

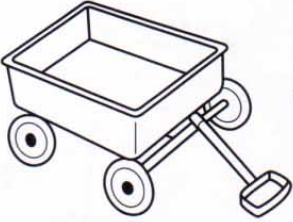
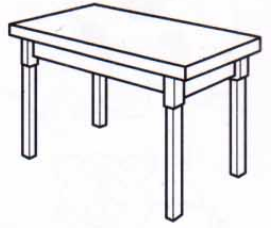

wagon

book

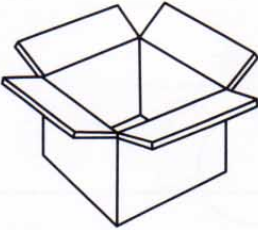
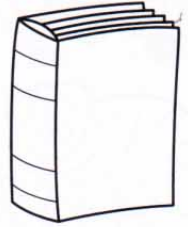

box

coin

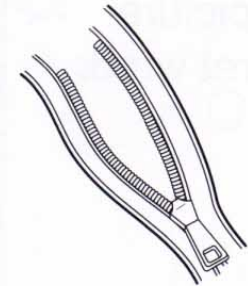
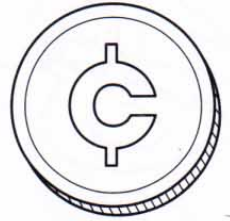

zipper

watch



zebra



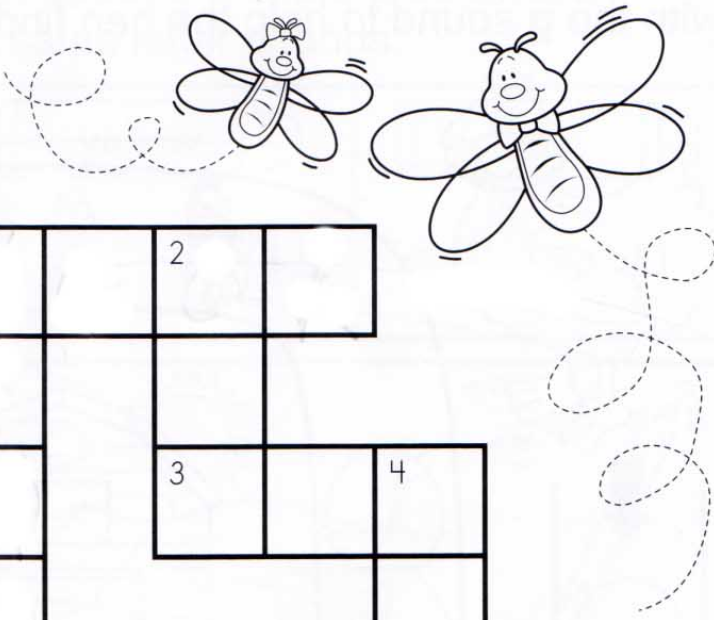

Use the words from the word list to solve the crossword puzzle.

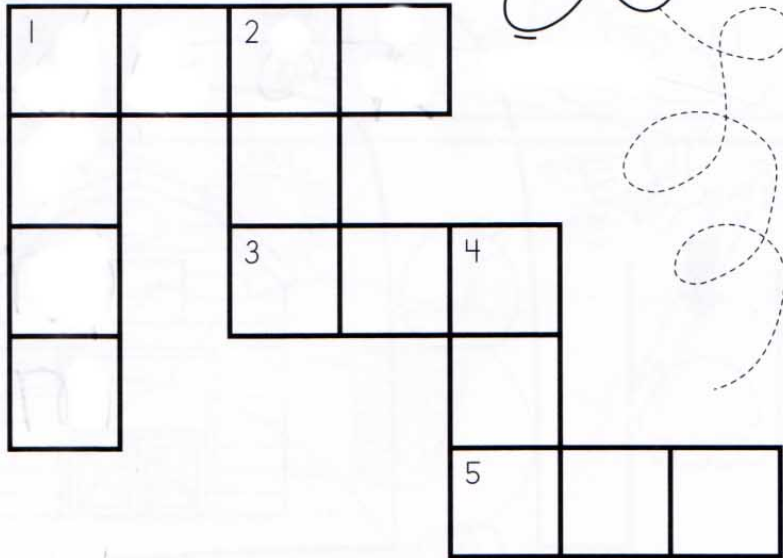

- Word List**
- bug
  - cub
  - drum
  - duck
  - gum
  - mug

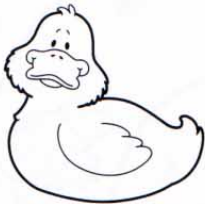
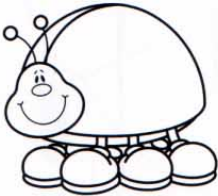

**Across**

1. 
3. 
5. 

**Down**

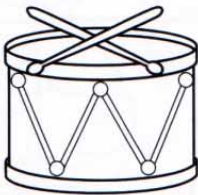
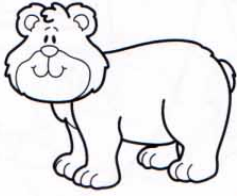
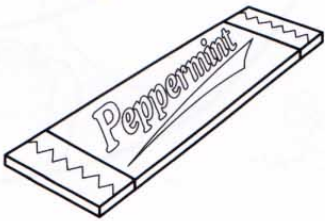



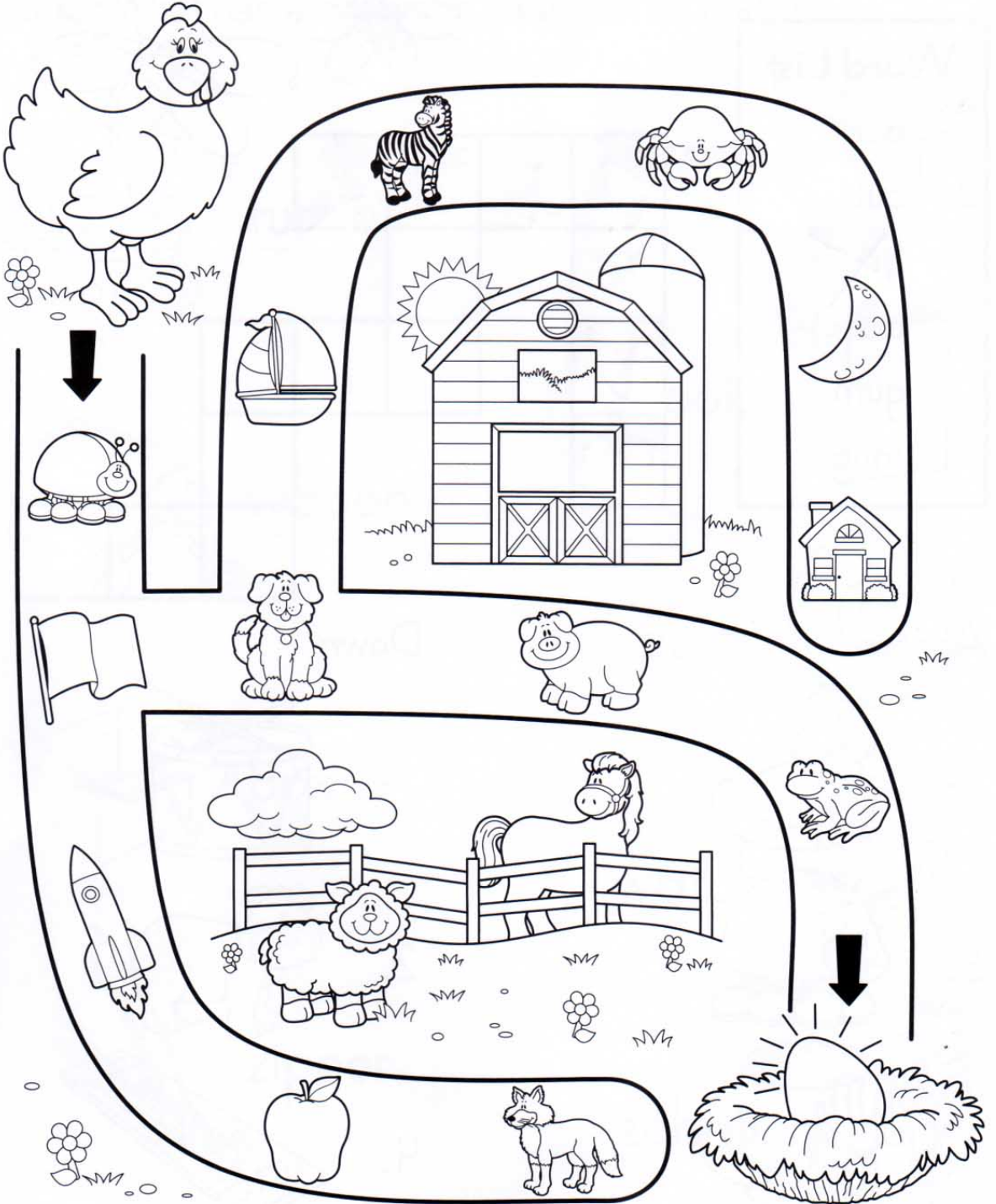

1. 
2. 
4. 

Draw a line along the path with pictures whose names **end** with the **g** sound to help the hen find the egg.





Use the key to color the spaces with pictures whose names **begin** with the same letter sounds.

 orange	 yellow	 blue
 n	 j	 p

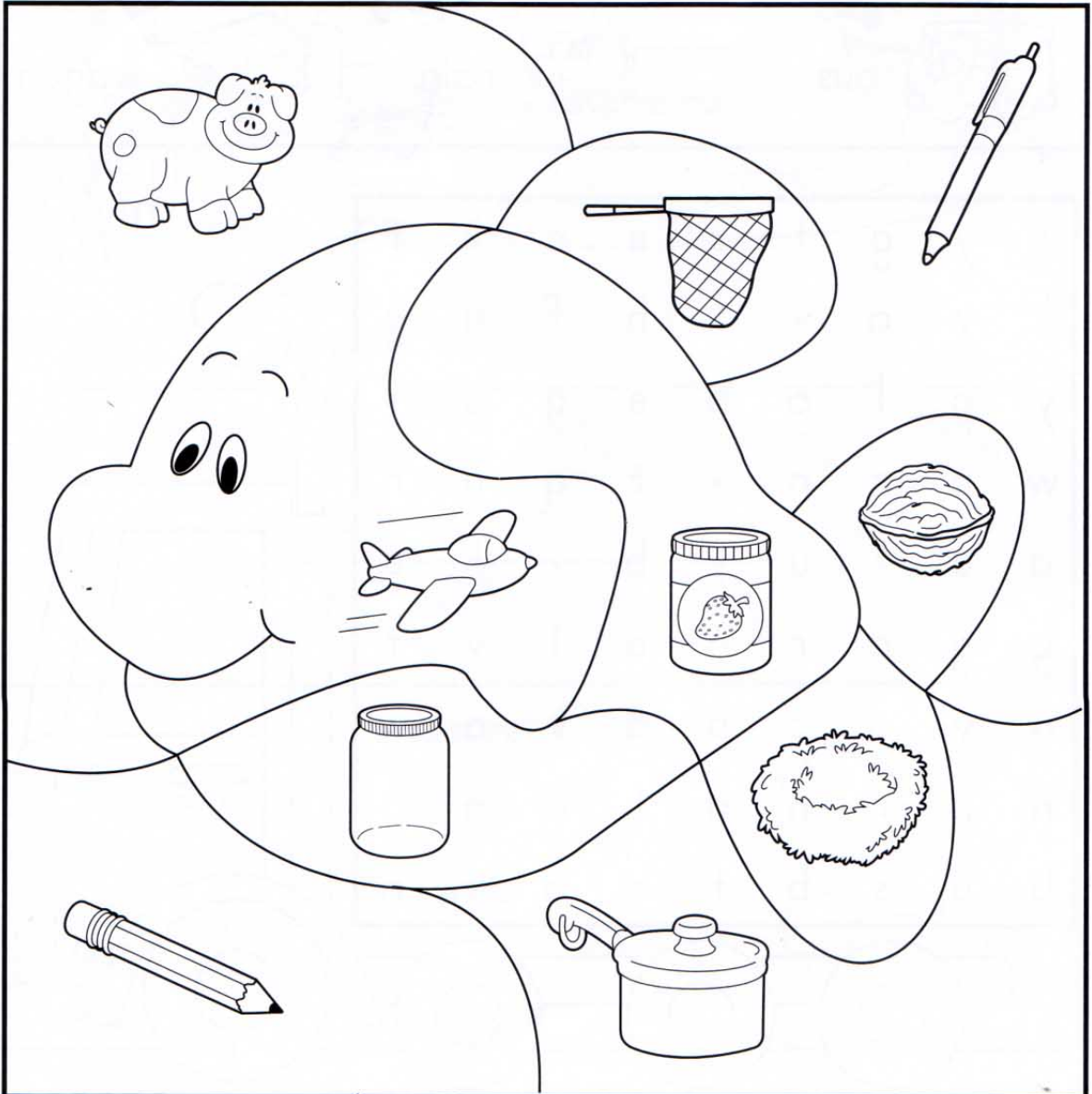

A large illustration of a bear's face, divided into several sections by lines. Various objects are scattered around the bear's face, each within a section. The objects are: a pig, a net, a pen, a bowl of spaghetti, a jar of jam, a bowl of spaghetti, a pencil, and a pot.



Circle the words from the word box in the puzzle below.



bike



car

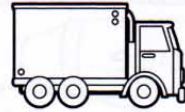

truck



boat



plane

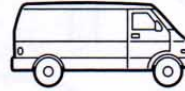

van

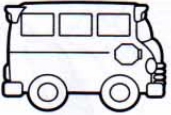

bus

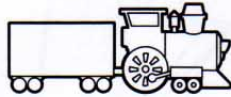

train



wagon

i y g t r u c k t  
k v a v t h f n g  
y p l a n e g b f  
w p r n x t q n n  
a u t u y b i k e  
g g c r o o l v t  
o y a c p a v c w  
n n r n n t o n c  
b u s b t r a i n

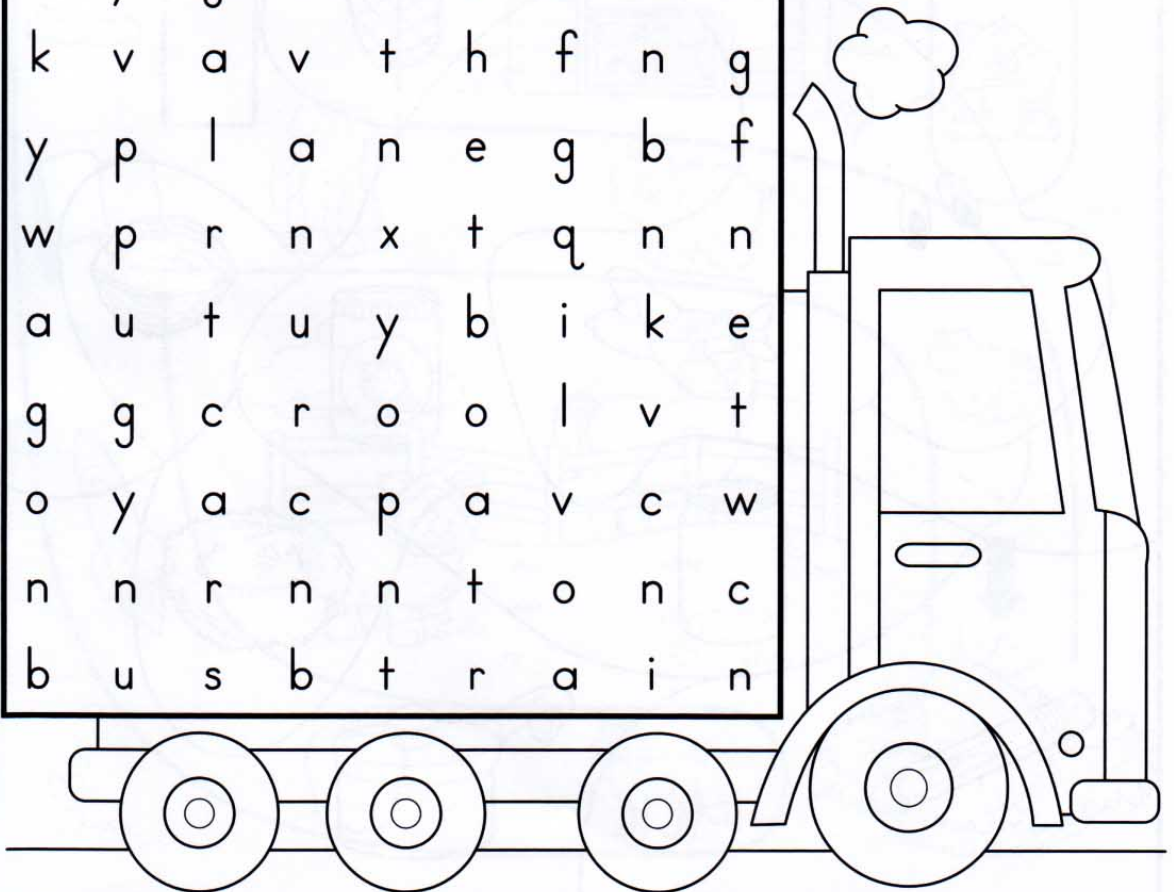

Use the secret code to solve the riddle.

Where do funny frogs sit?

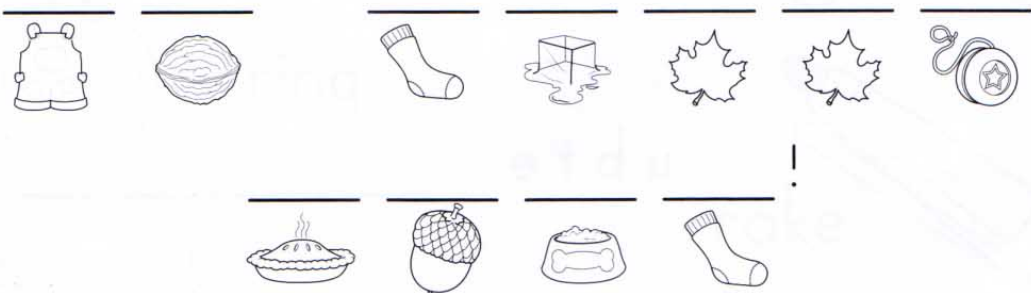
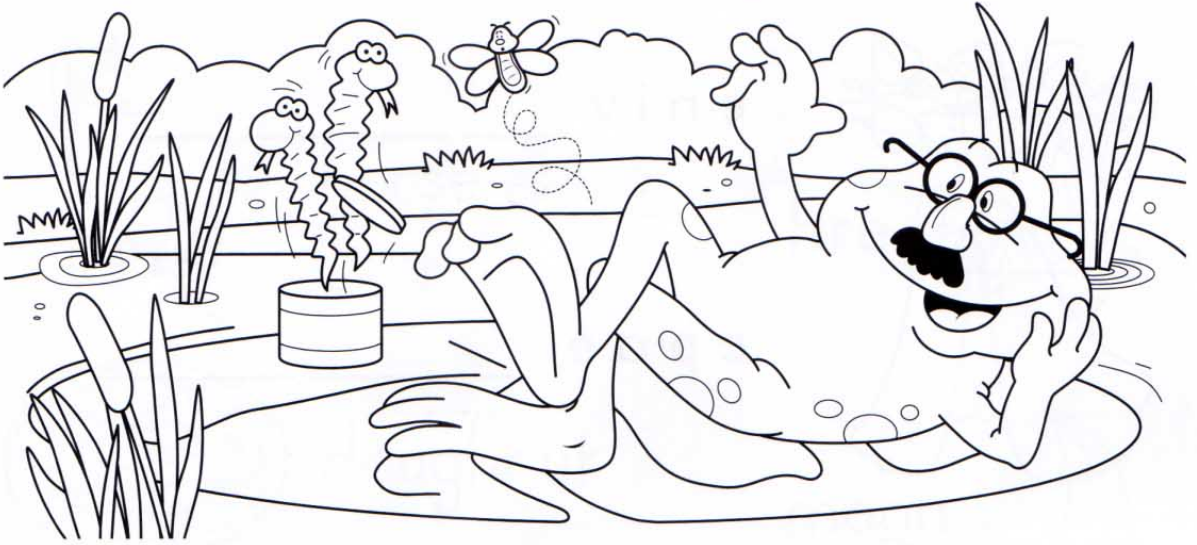

Secret Code

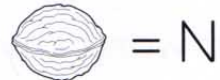
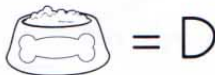
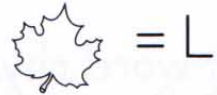
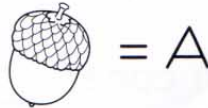
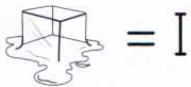
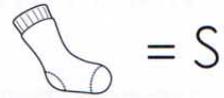
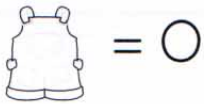

Unscramble each word and write it on the lines. Then, use the words to answer the questions.

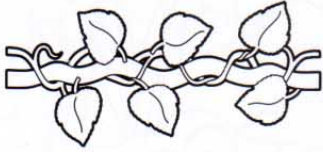

e n i v \_\_\_\_\_



c p a e \_\_\_\_\_

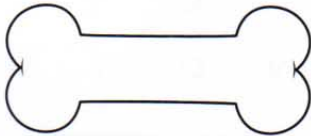

n b o e \_\_\_\_\_

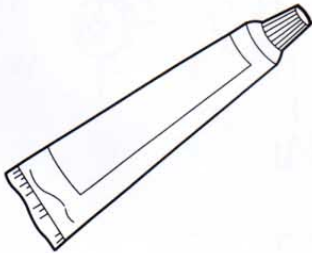

u b t e \_\_\_\_\_

What word rhymes with cube? \_\_\_\_\_

What word rhymes with tape? \_\_\_\_\_

What word rhymes with cone? \_\_\_\_\_

What word rhymes with nine? \_\_\_\_\_

Draw lines to match the words with the same **beginning** sound. Circle the picture that is left. It is the answer to the riddle: What nut has a hole in the middle?

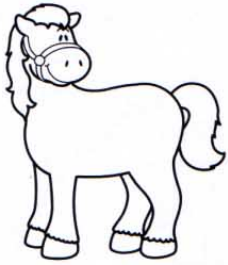

horse



fire

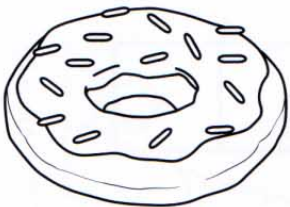

doughnut

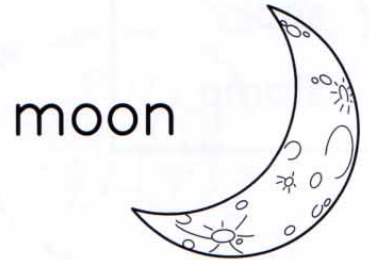

moon

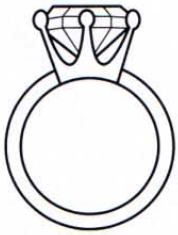

ring

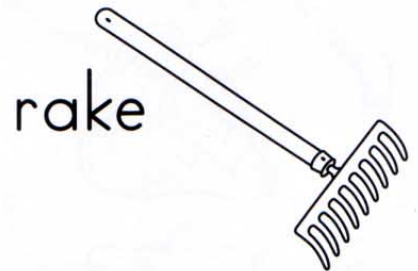

rake

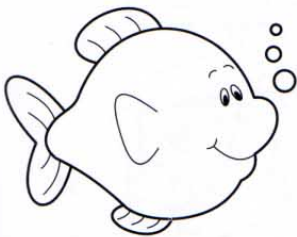

fish

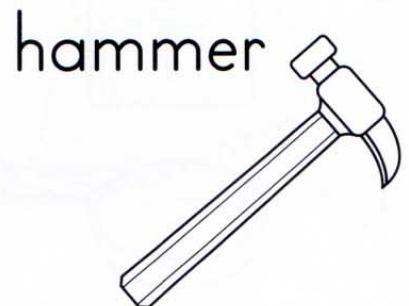

hammer



mitten



Use the words from the word list to solve the crossword puzzle.

### Word List

ham

hat

map

pan

sack

stamp

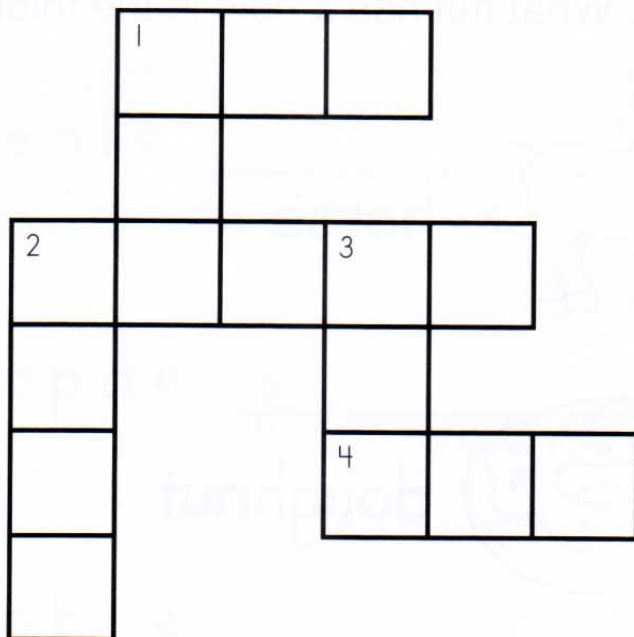

### Across

1.

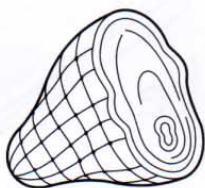

2.



4.



### Down

1.



2.

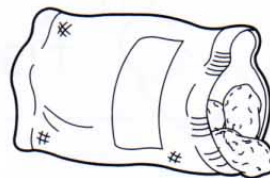



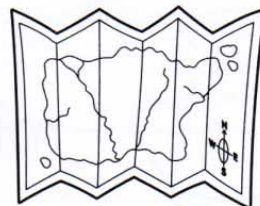

3.

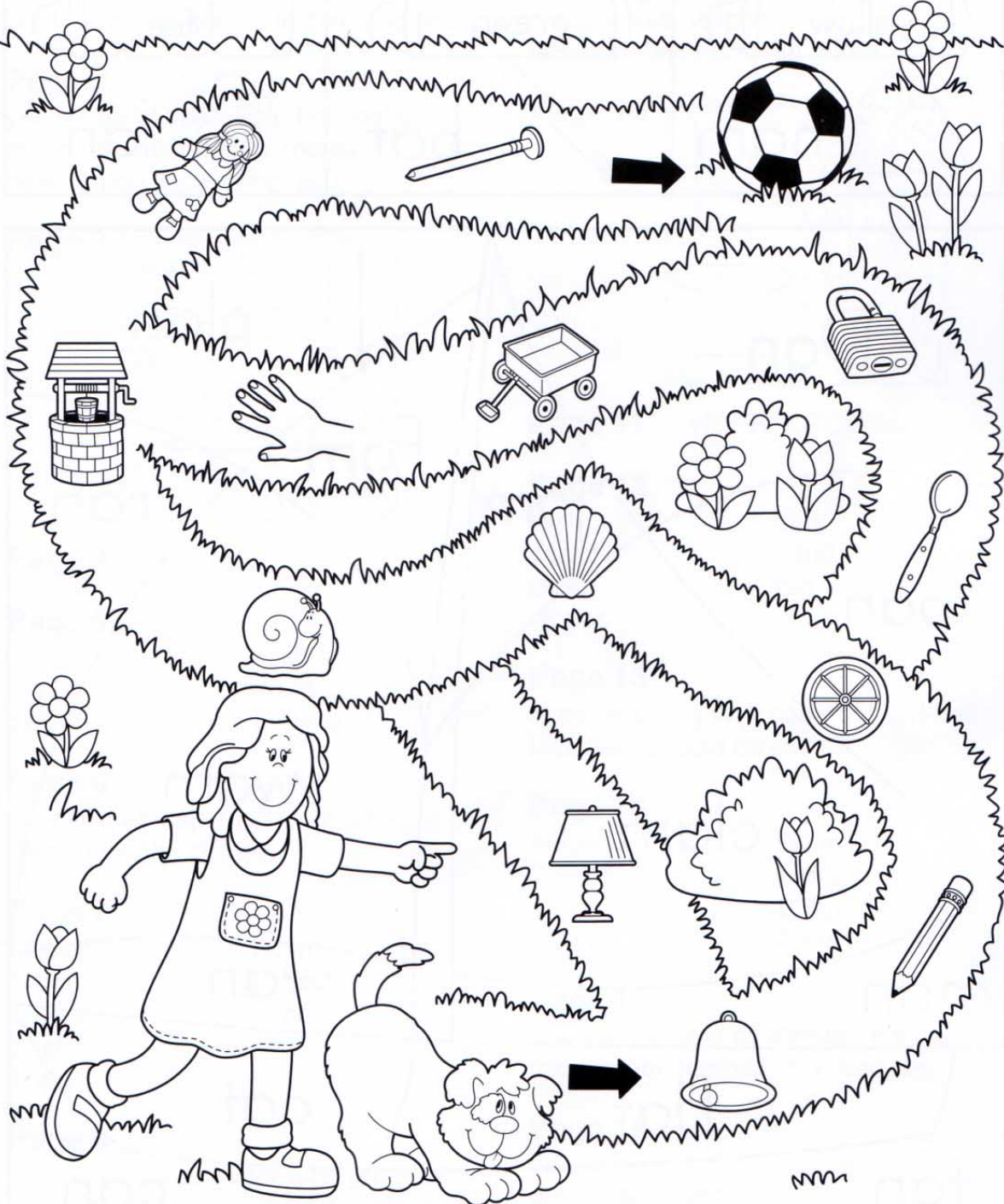

Draw a line along the path with pictures whose names **end** with the **I** sound to help the girl find the ball.

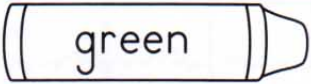

Use the key to color the spaces with words that **rhyme**.

 yellow	 green	 blue
 ham	 bat	 fan

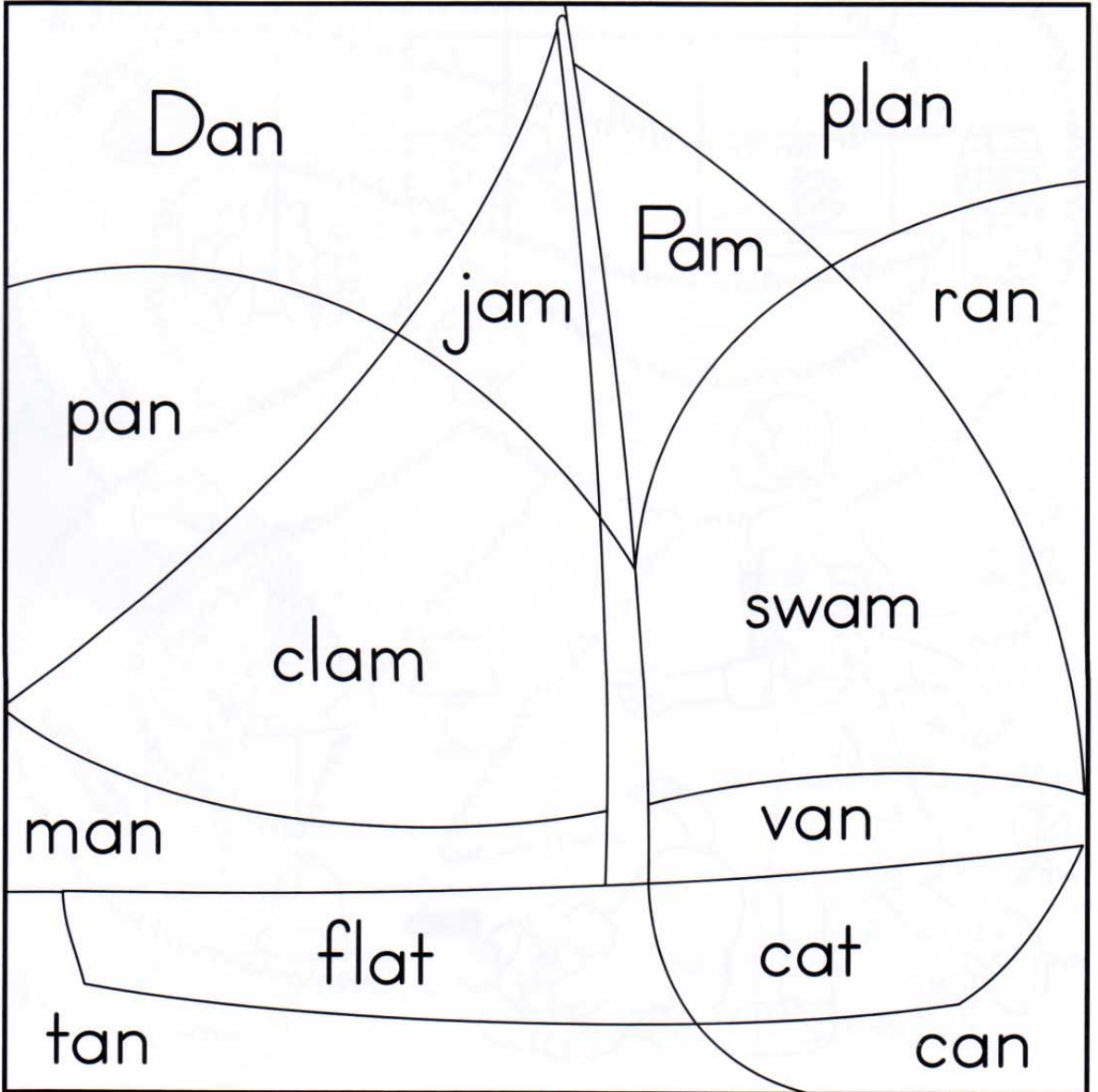

Dan plan Pam jam ran pan clam swam man van flat cat tan can



Circle the number words from the word box in the puzzle below.

0 zero	3 three	6 six	9 nine
1 one	4 four	7 seven	10 ten
2 two	5 five	8 eight	

1  
2  
3  
4  
5  
6

Use the secret code to solve the riddle.

What kind of beans do not grow in a garden?

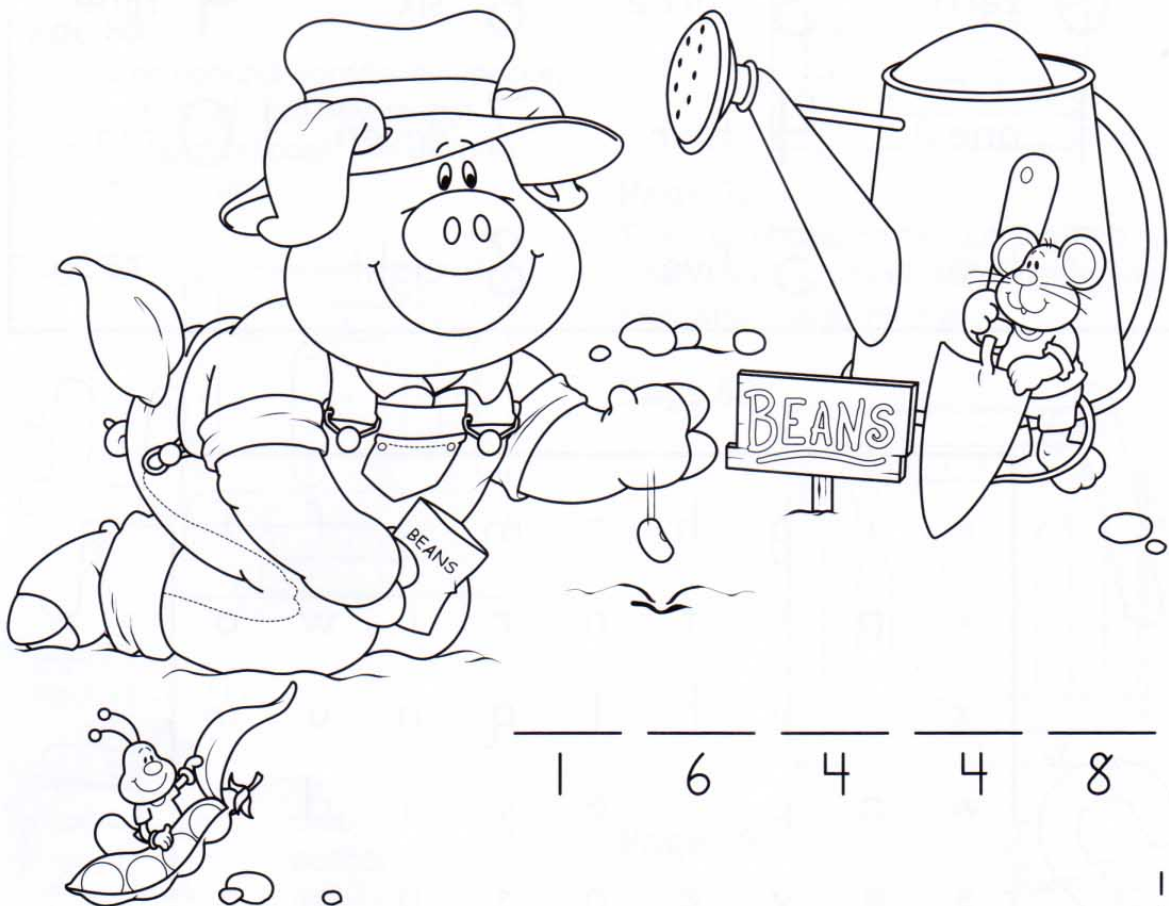

1 6 4 4 8  
5 6 2 3 7 !

### Secret Code

4 = L

8 = Y

6 = E

2 = A

7 = S

1 = J

3 = N

5 = B

Unscramble each word and write it on the lines. Then, write the circled letters in order to answer the riddle.



t r a s

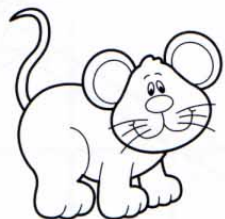
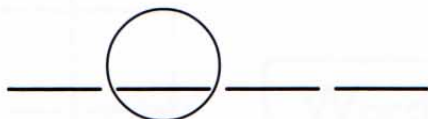

e o s u m

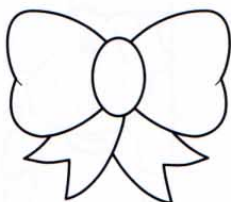
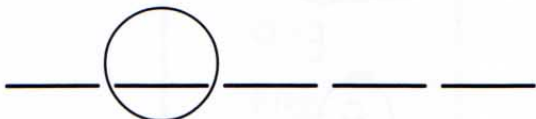

o b w

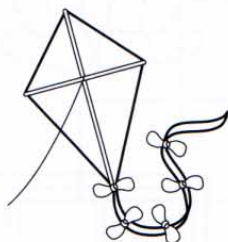
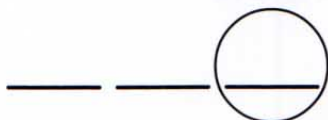

t k i e



g l i r

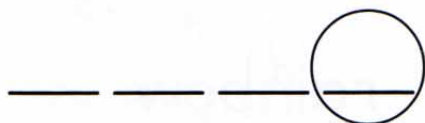

What gets wetter the more it dries?

a





Draw lines to match the words with the same **beginning** sound. Circle the picture that is left. It is the answer to the riddle: What kind of bow cannot be tied?



sock

nail

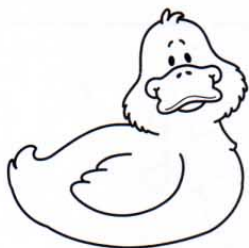
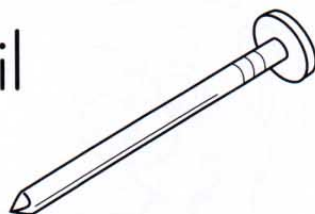

duck

dog



nest

window

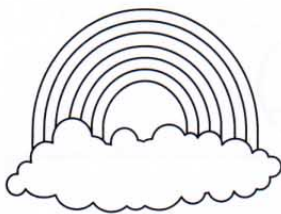
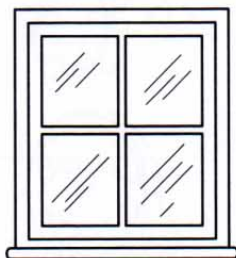

rainbow

saw

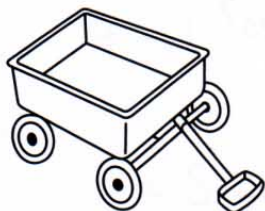

wagon

Use the words from the word list to solve the crossword puzzle.

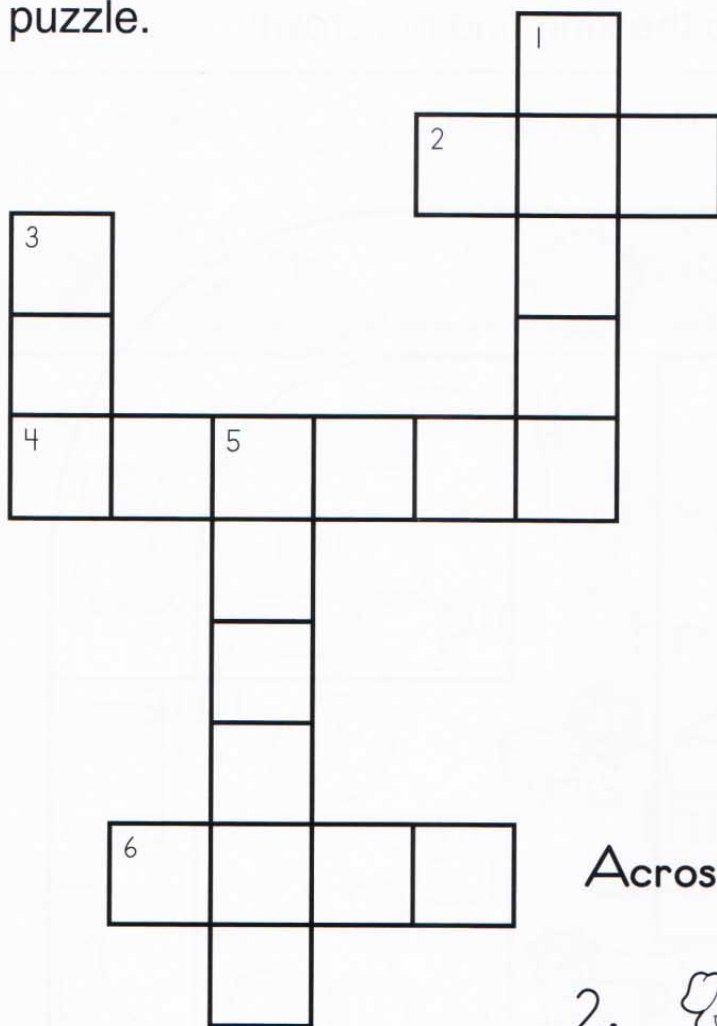

**Word List**

cat  
dog  
fish  
mouse  
rabbit  
turtle

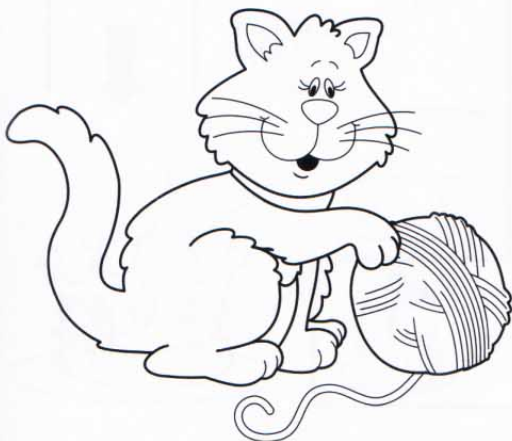

**Across**

**Down**

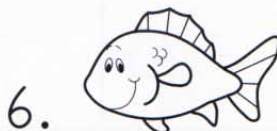
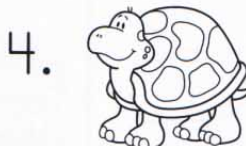

Circle the words from the word box in the puzzle below.

birthday

friends

hat

cake

fun

present

candles

games

sing





Use the secret code to solve the riddle.

How do bees get to school?



4

1

2

“

”!

6

8

5

5



### Secret Code

8 = U

6 = B

1 = N

9 = S

2 = A

3 = M

5 = Z

4 = O

Unscramble each word and write it on the lines. Then, use the words to finish the sentences below.



p y u p p    \_ \_ \_ \_ \_



z p r i e    \_ \_ \_ \_ \_



s o h e    \_ \_ \_ \_ \_

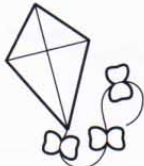

t e k i    \_ \_ \_ \_ \_



g e c a    \_ \_ \_ \_ \_

1. The \_\_\_\_\_ is in the garden.

2. Sam won first \_\_\_\_\_.

3. We flew a \_\_\_\_\_ today.

4. The bird was in the \_\_\_\_\_.

5. The \_\_\_\_\_ is very cute.

Draw lines to match words that go together to make compound words. Use the compound words to finish the sentences below.



cup

ball

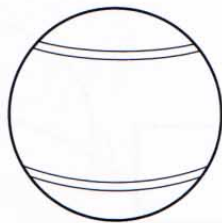

foot

bell

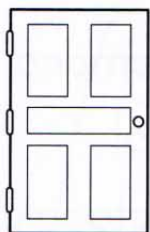

door

cake



doll

house

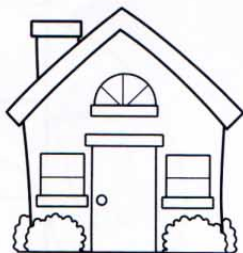

1. We played \_\_\_\_\_ outside.

2. Pam had a \_\_\_\_\_ on her birthday.

3. Sara has a pretty pink \_\_\_\_\_.

4. Please ring the \_\_\_\_\_.



Use the words from the word list to solve the crossword puzzle.

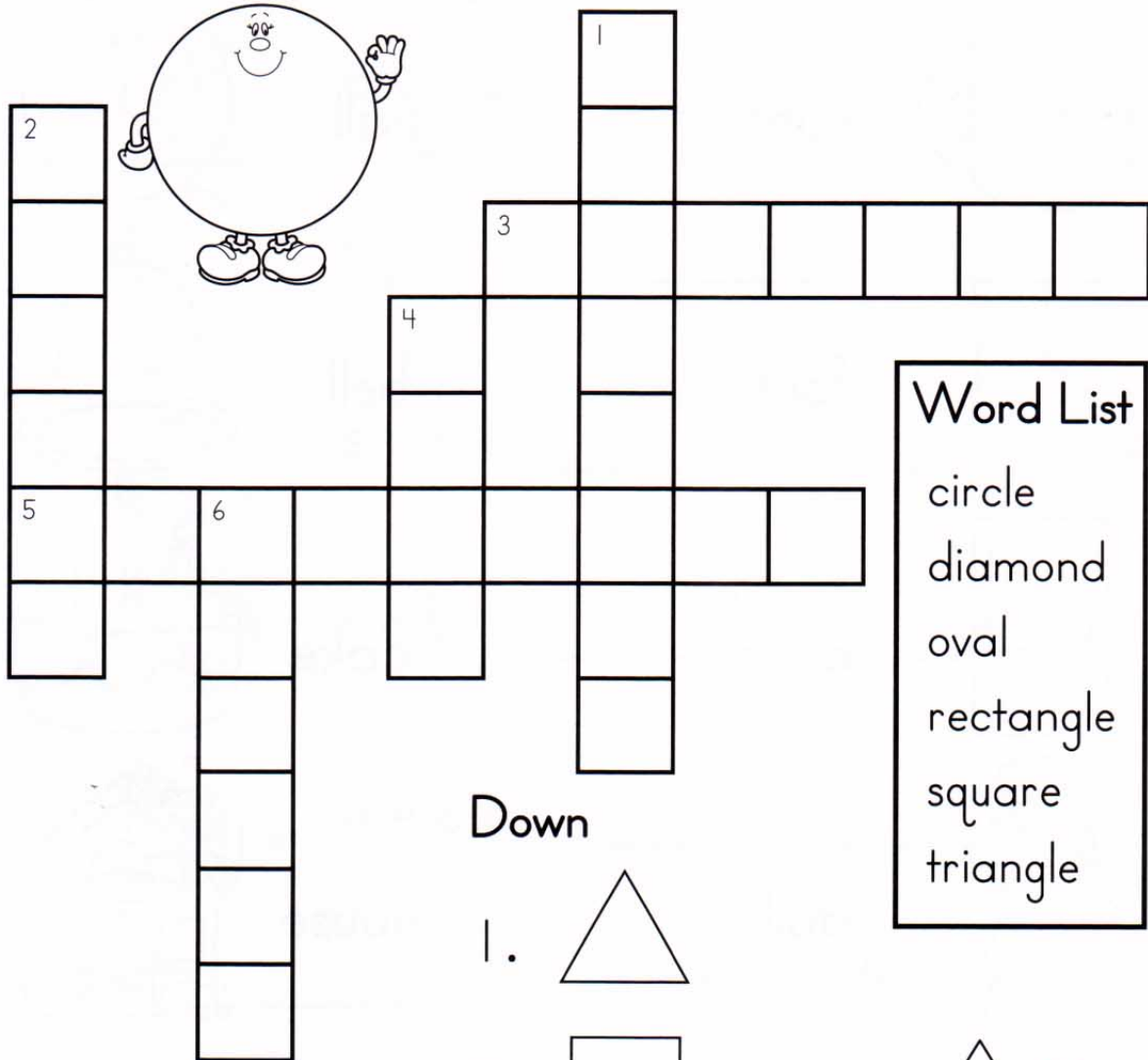
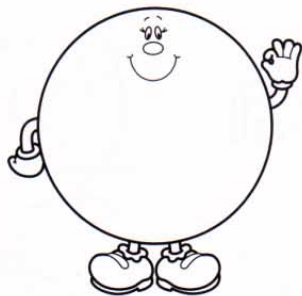

**Word List**  
 circle  
 diamond  
 oval  
 rectangle  
 square  
 triangle

**Across**

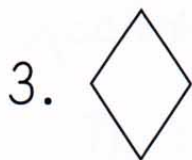



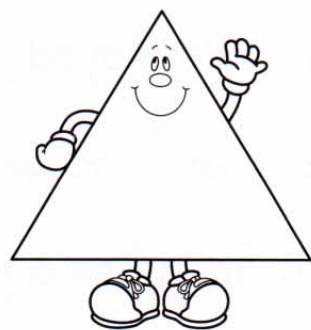

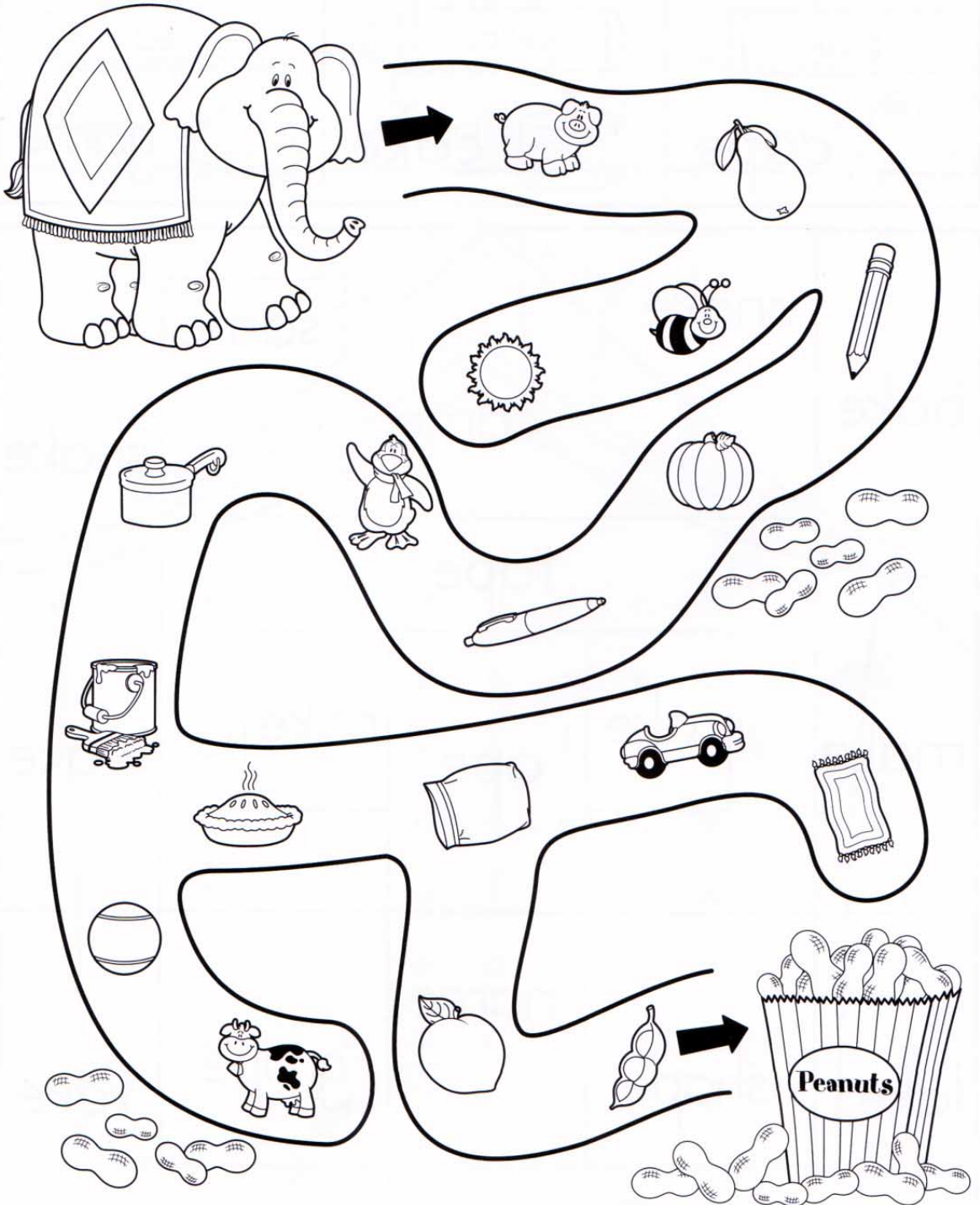

**Down**



Draw a line along the path with pictures whose names **begin** with the **p** sound to help the elephant find the peanuts.



Use the key to color the spaces with words that **rhyme**.

 blue	 yellow	 red
 cape	 cake	 game

bake	snake	same		shake
	came			
make	tape			wake
	take	ape	rake	
	lake	shape	name	



Use the secret code to solve the riddle.

What do ducks eat for a snack?

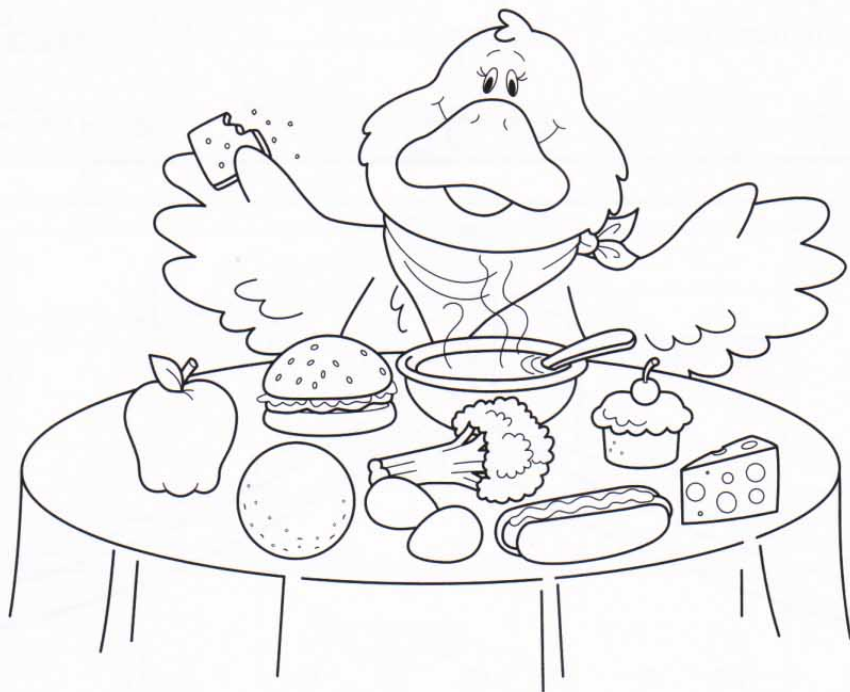

“

”

5 7 9 2 6 3 4 8 !

### Secret Code

7 = U

5 = Q

2 = C

8 = S

9 = A

6 = K

4 = R

3 = E

Unscramble each describing word and write it on the lines. Then, write the circled letters in order to answer the riddle.

cute

happy

noisy

sleepy

funny

neat

pretty

h y a p p    \_\_\_\_\_ ( ) \_\_\_\_\_

f n n u y    \_\_\_\_\_ ( ) \_\_\_\_\_

s p l e e y    \_\_\_\_\_ ( ) \_\_\_\_\_

u t e c    ( ) \_\_\_\_\_

n s o i y    \_\_\_\_\_ ( ) \_\_\_\_\_

r e t p t y    \_\_\_\_\_ ( ) \_\_\_\_\_

a n e t    ( ) \_\_\_\_\_



What do dogs eat at the movies?

“ \_\_\_\_\_ ” !  
\_\_\_\_\_

Use the words from the word list to solve the crossword puzzle.

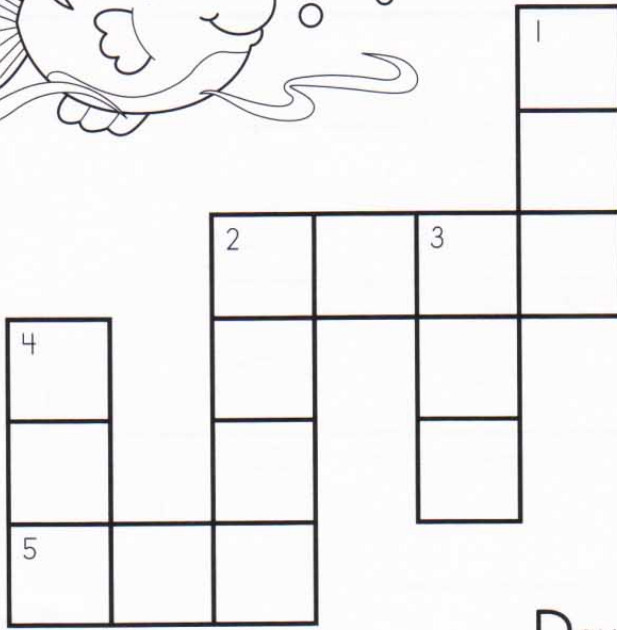
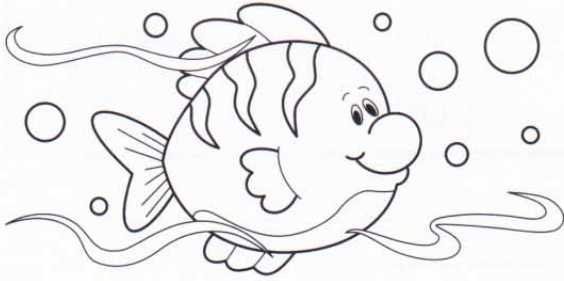

**Word List**

fin  
 gift  
 grin  
 kit  
 lip  
 pin

Down

Across



Draw a line along the path with pictures whose names **end** with the **r** sound to put the coin in the piggy bank.

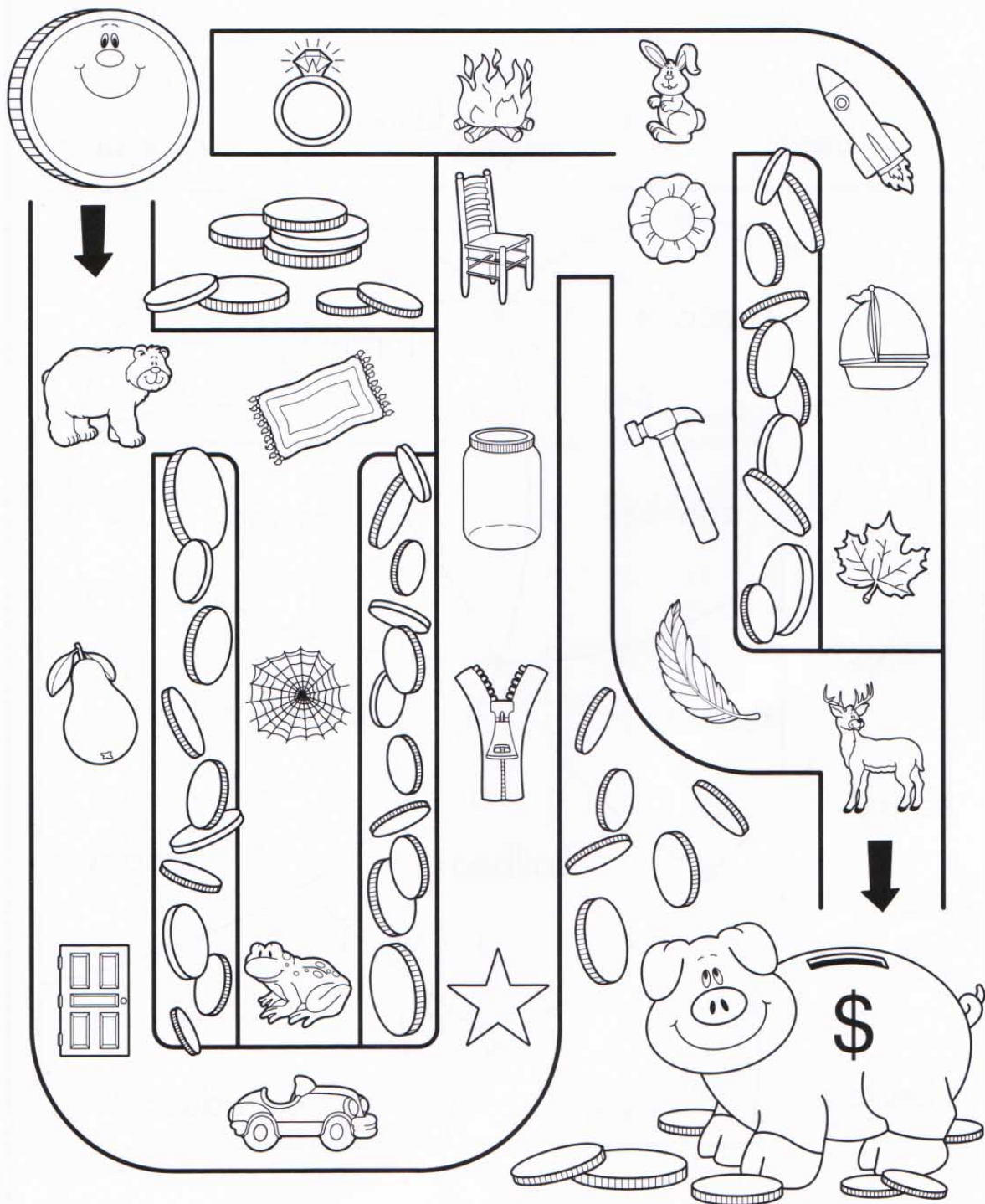



Use a red crayon to color each space that contains a real compound word.

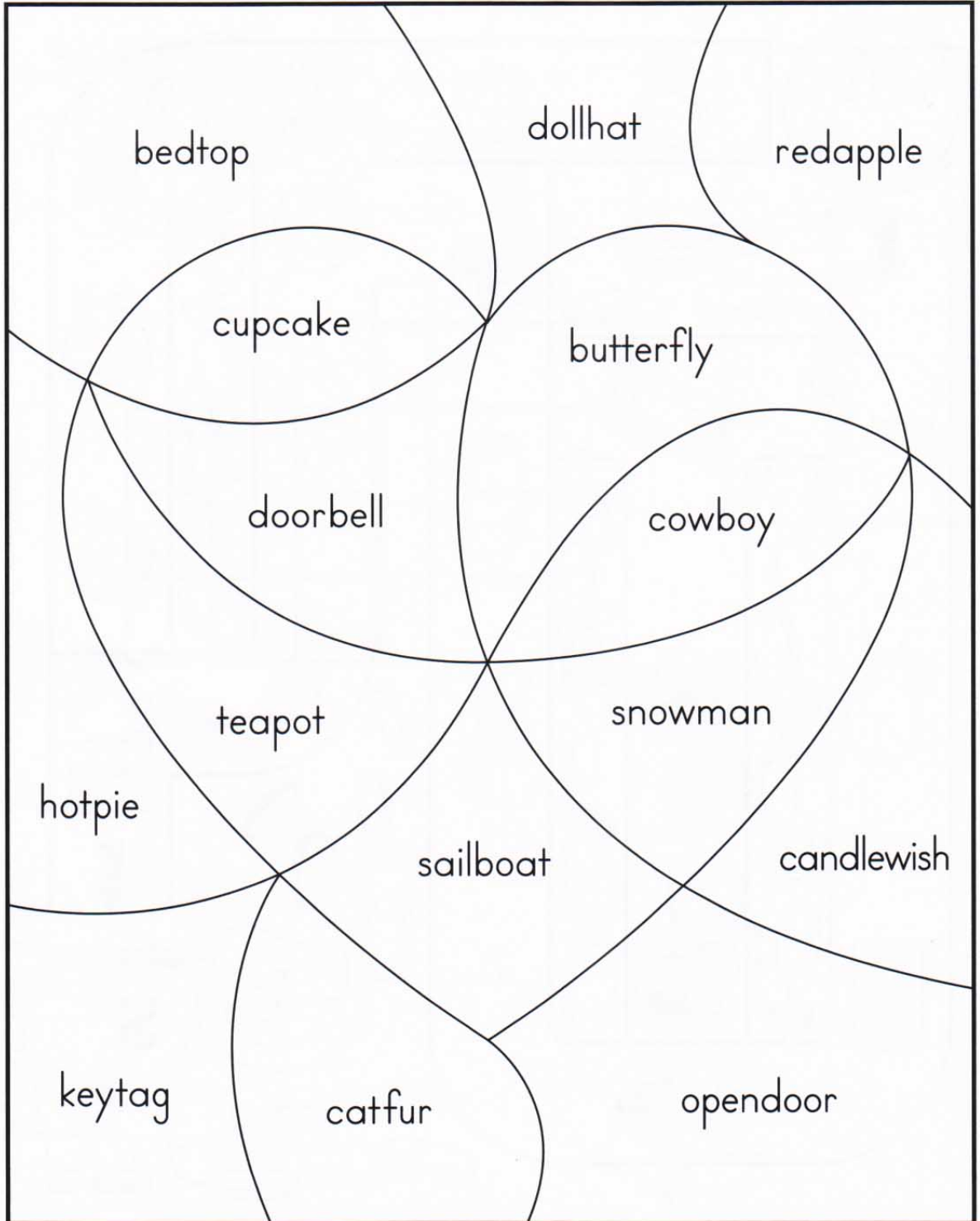

Circle the words from the word box in the puzzle below.

apple

juice

pizza

banana

lunch

sandwich

cookie

milk

soup

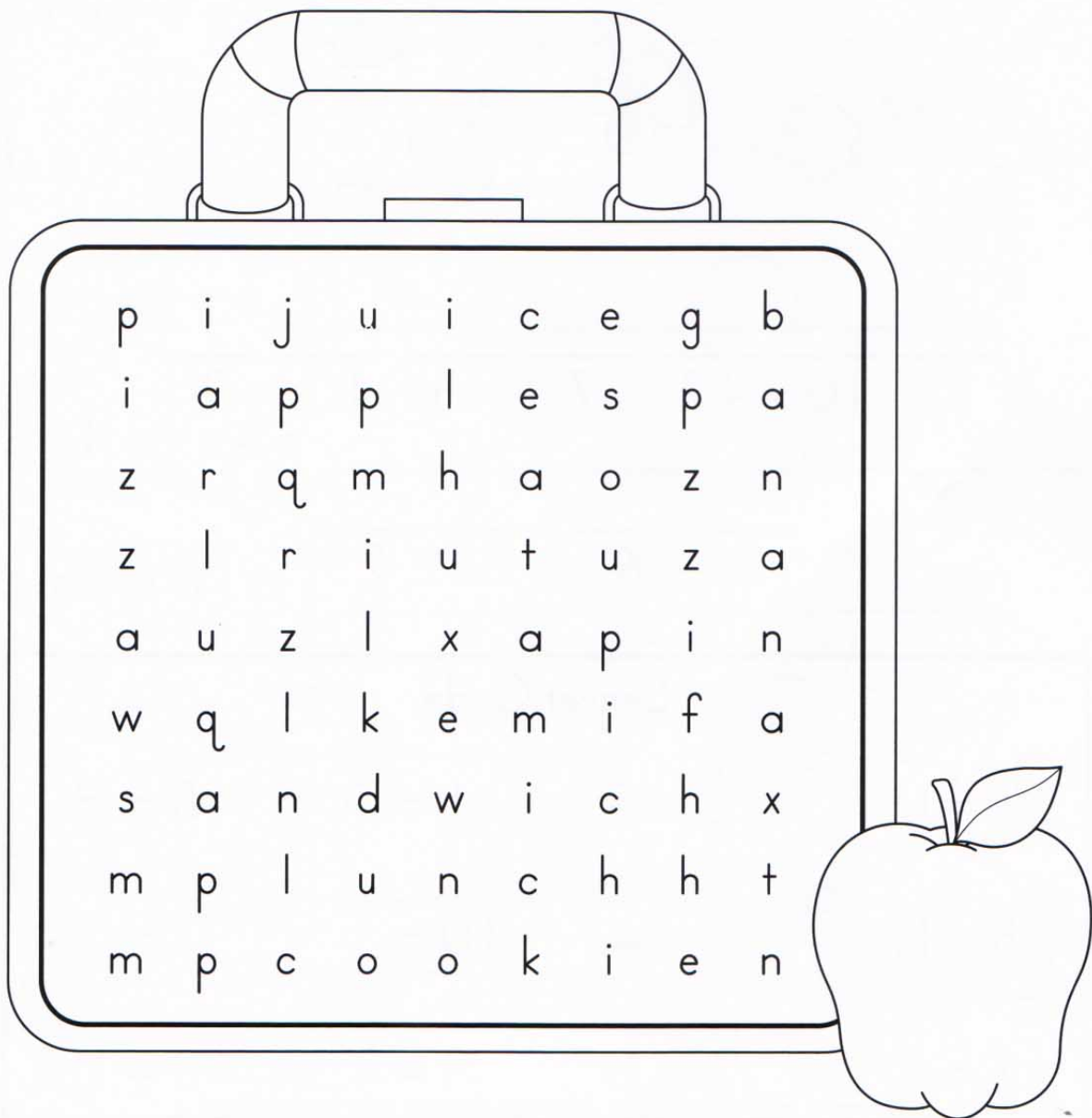

Use the secret code to solve the riddle.

What is a dog's favorite sport?

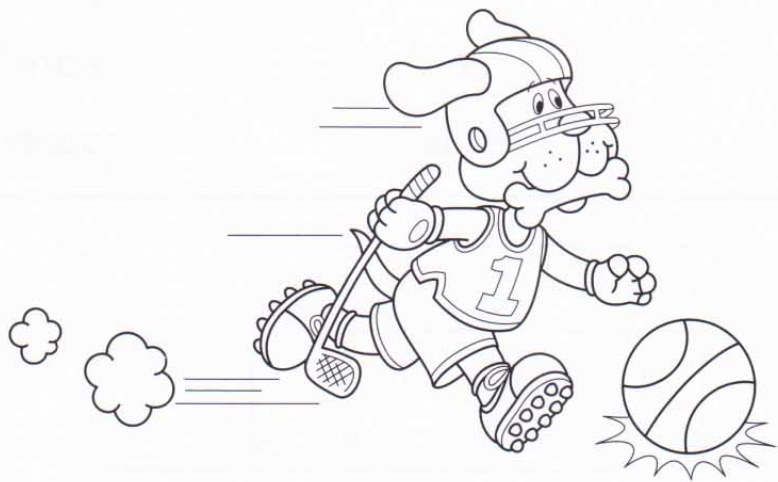

“

”

8 10 12 7 14 10 9 —

8 6 2 2 !

### Secret Code

14 = U

12 = S

1 = D

8 = B

5 = N

6 = A

10 = I

7 = C

11 = J

2 = L

9 = T

3 = Y

Unscramble each animal name and write it on the lines.  
Write the circled letters in order to find the secret word.

crab

gull

oyster

shark

dolphin

lobster

seahorse

steroy

bcra



blostre

ashorseee

ndlphio

lgul

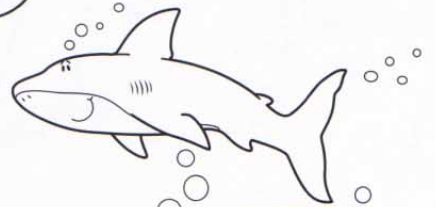

ksarh



Secret Word

\_\_\_\_\_



Circle the words from the word box in the puzzle below.

desk

notebook

school

homework

paper

student

learn

pencil

teacher

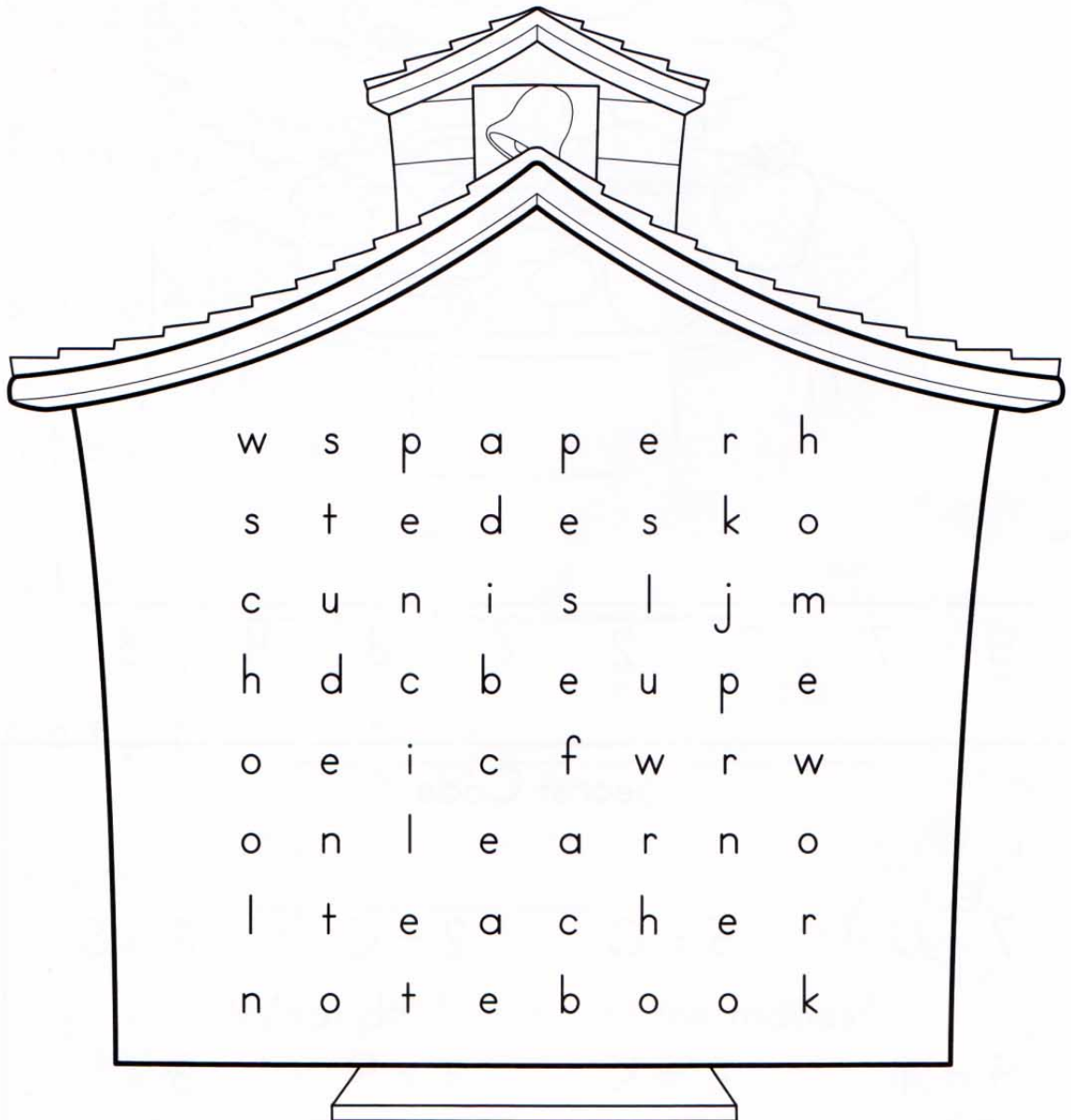

Use the words from the word list to solve the crossword puzzle.

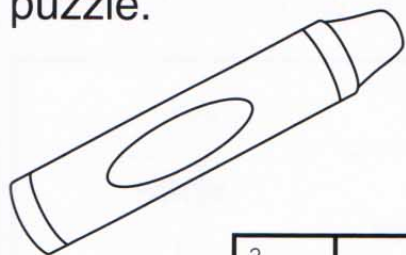

### Word List

blue  
green  
orange  
purple  
red  
yellow

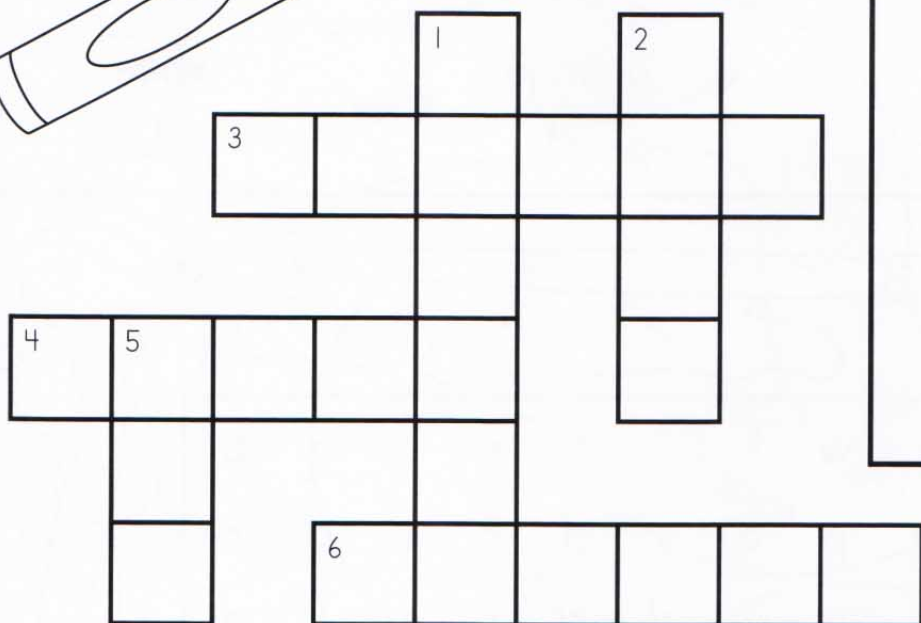

### Across

3. The grapes are \_\_\_\_\_.
4. The leaf is \_\_\_\_\_.
6. The sun is \_\_\_\_\_.

### Down

1. The pumpkin is \_\_\_\_\_.
2. My jeans are \_\_\_\_\_.
5. The apple is \_\_\_\_\_.

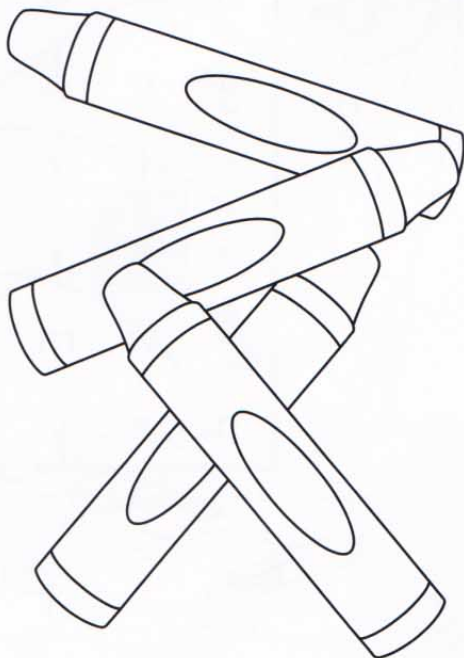

Circle the color words from the word box in the puzzle below.

black

green

red

blue

orange

white

brown

purple

yellow

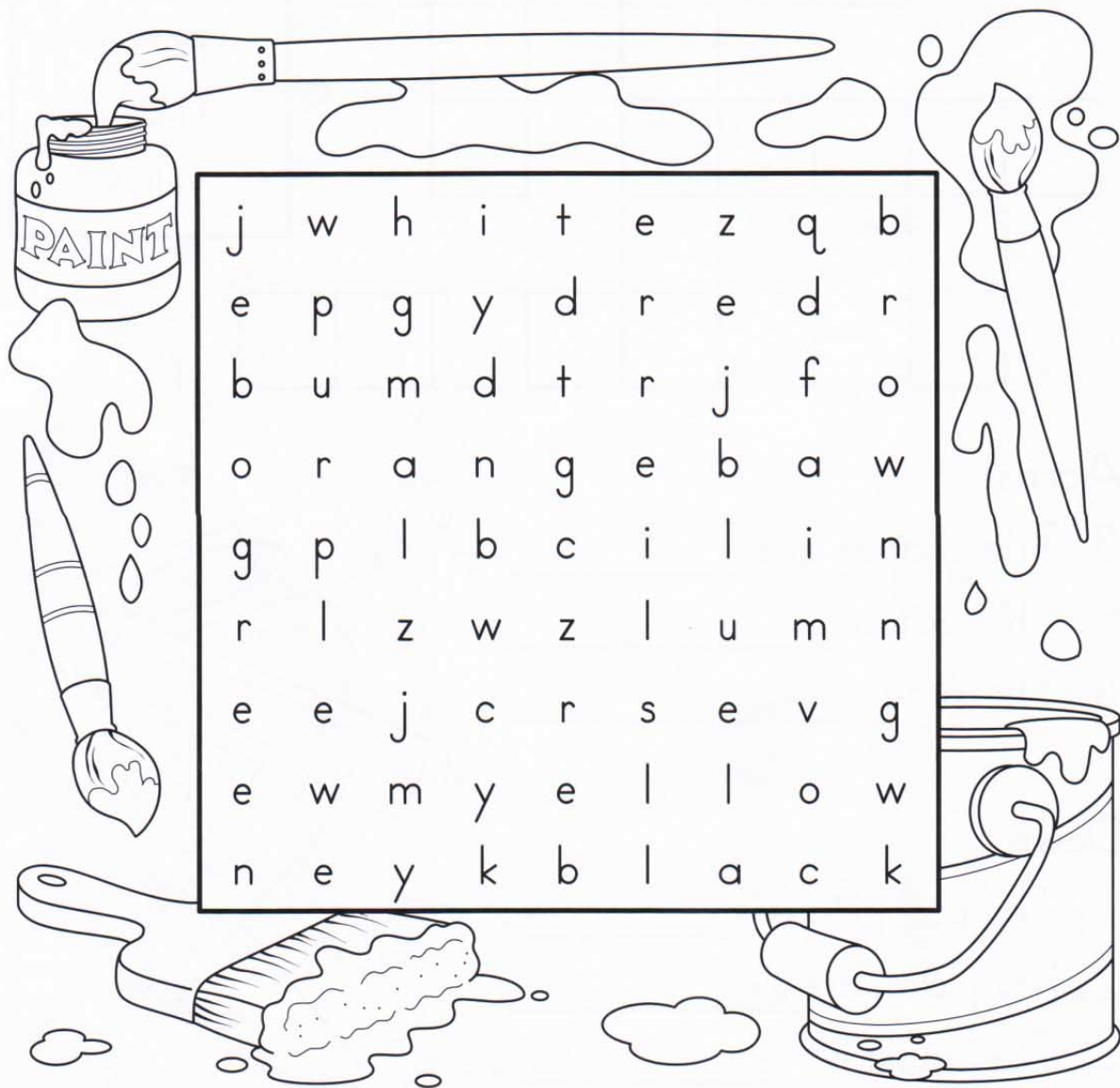

j	w	h	i	t	e	z	q	b
e	p	g	y	d	r	e	d	r
b	u	m	d	t	r	j	f	o
o	r	a	n	g	e	b	a	w
g	p	l	b	c	i	l	i	n
r	l	z	w	z	l	u	m	n
e	e	j	c	r	s	e	v	g
e	w	m	y	e	l	l	o	w
n	e	y	k	b	l	a	c	k

Draw a line along the path with pictures whose names **begin** with the **w** sound to help the boy find his wagon.

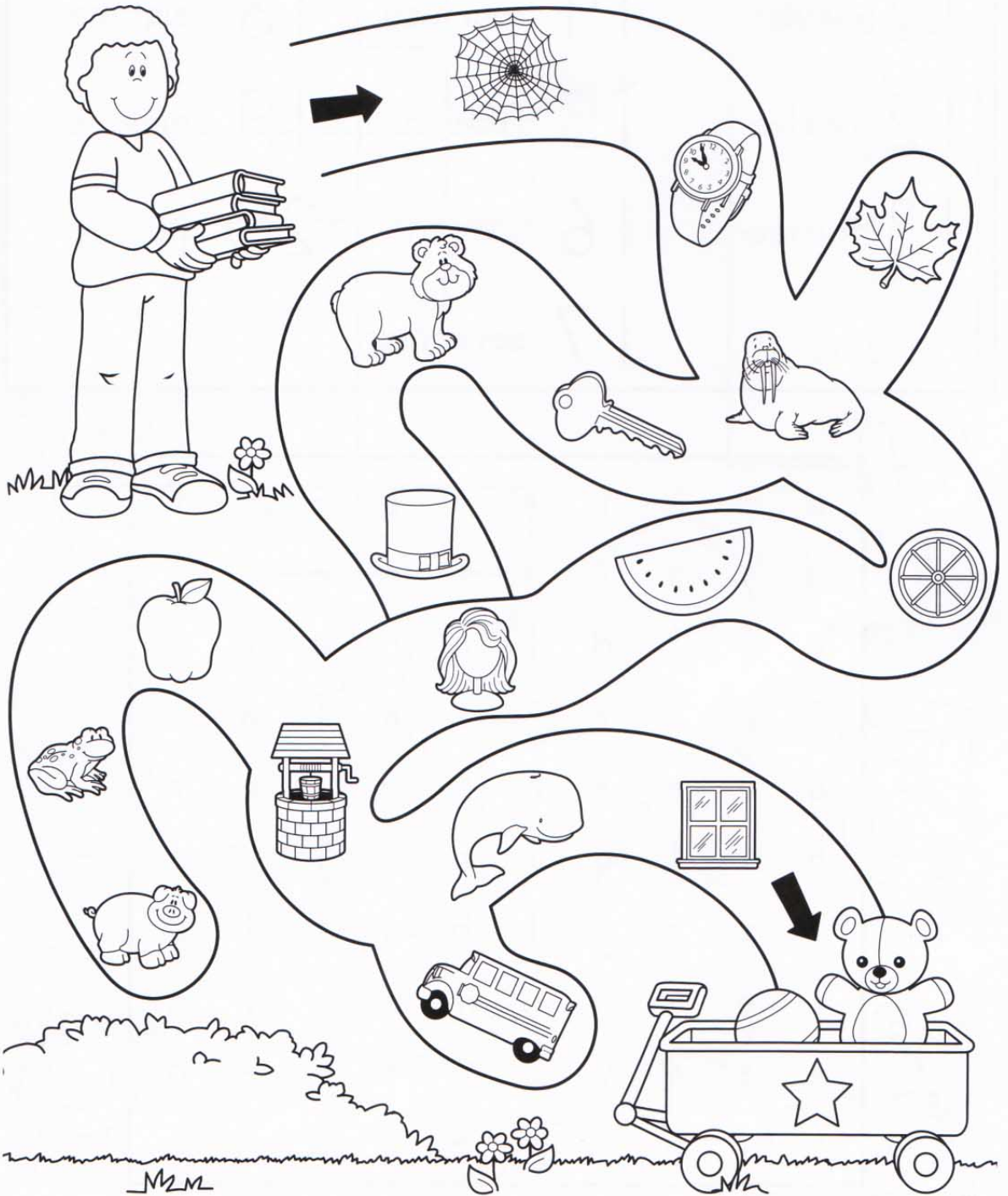



Circle the number words from the word box in the puzzle below.

11	eleven	14	fourteen	18	eighteen
12	twelve	15	fifteen	19	nineteen
13	thirteen	16	sixteen	20	twenty
		17	seventeen		

4

5

6

8

9

b	t	h	i	r	t	e	e	n	f
d	y	s	i	x	t	e	e	n	o
e	t	l	d	l	u	h	e	t	u
i	w	f	z	j	l	e	f	w	r
g	e	e	k	h	b	r	i	e	t
h	l	l	q	l	o	z	f	n	e
t	v	e	j	l	b	u	t	t	e
e	e	v	n	a	m	o	e	y	n
e	s	e	v	e	n	t	e	e	n
n	i	n	e	t	e	e	n	n	b

Use the word from the word list that is the opposite of each clue to solve the crossword puzzle.

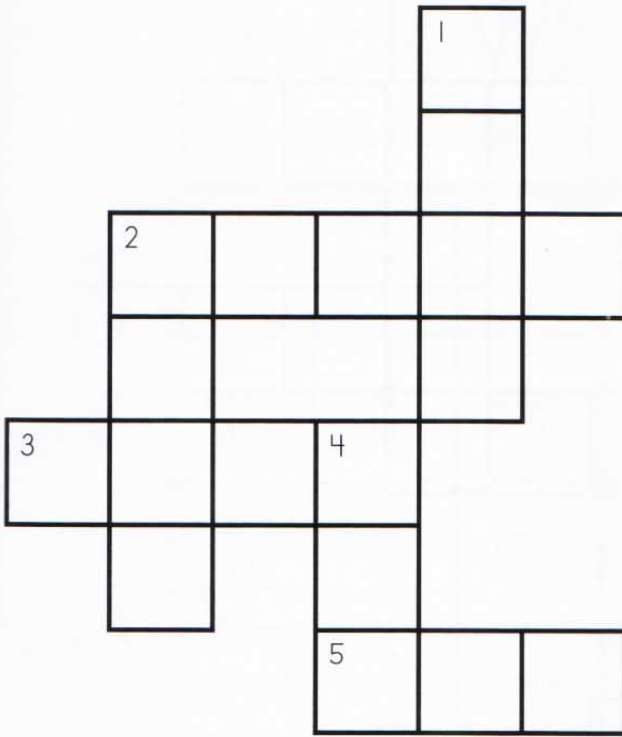

**Word List**  
 cold  
 down  
 new  
 small  
 stop  
 wet

**Across**

- 2. big
- 3. up
- 5. dry

**Down**

- 1. hot
- 2. go
- 4. old

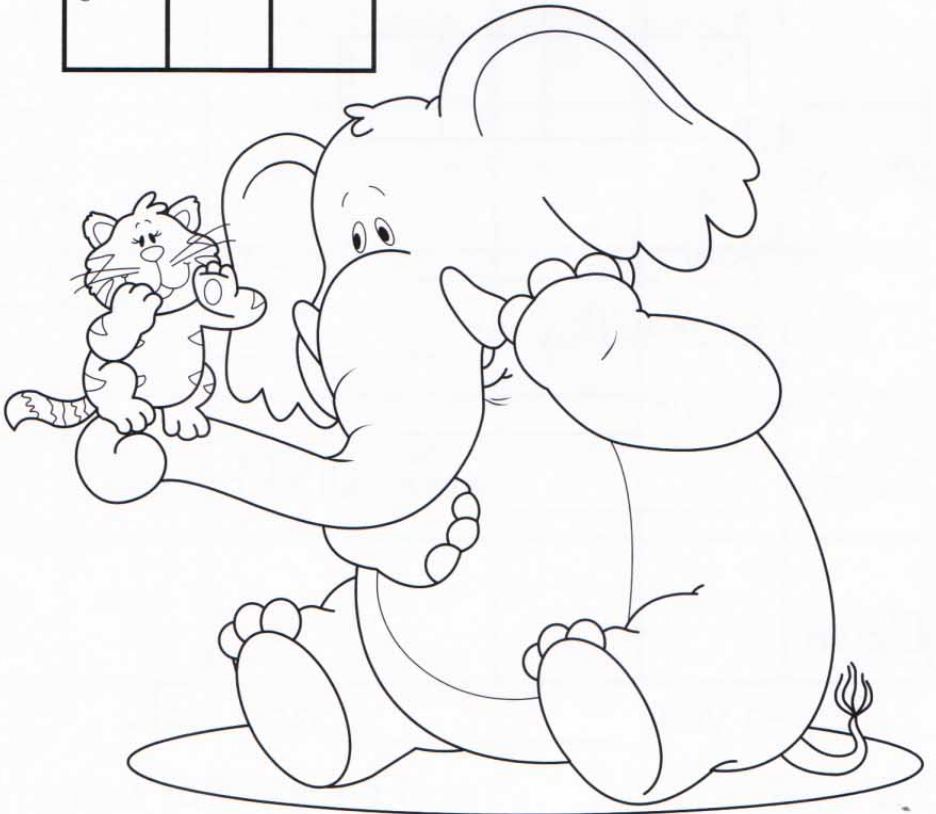

Use the words from the word list to solve the crossword puzzle.

### Word List

arms

hair

ears

hands

eyes

legs

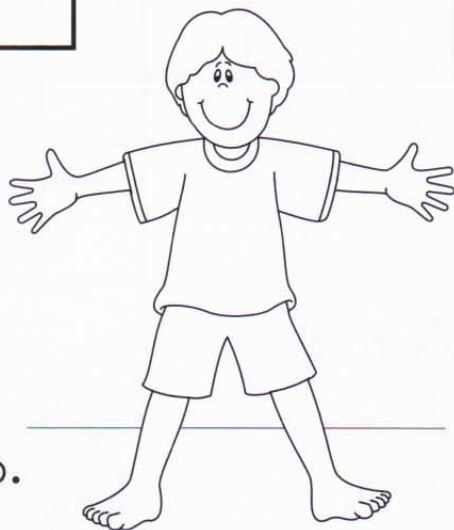
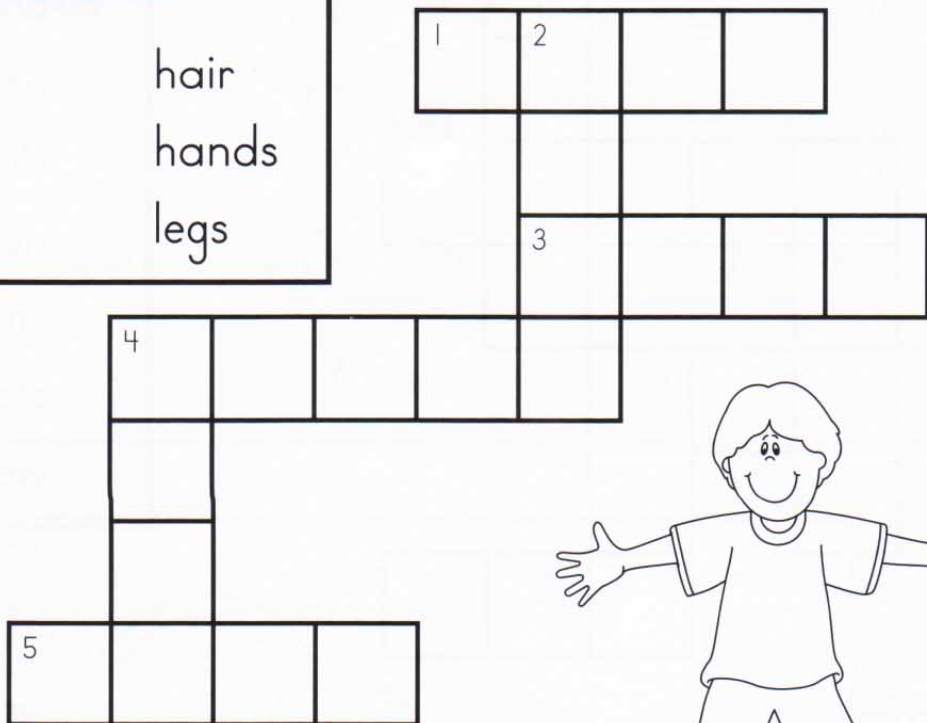

### Across

1. Use your \_\_\_\_\_ to jump.
3. You hear with your \_\_\_\_\_.
4. Clap your \_\_\_\_\_.
5. Her \_\_\_\_\_ were full of books.

### Down

2. Open your \_\_\_\_\_ and look.
4. Your \_\_\_\_\_ can be short or long.

# Word Puzzles and Games: Grades K-1 Answer Key

## Page 1

The path should go through the ball, box, boat, book, balloon, bell, bat, and bee.

## Page 2

yellow: bear, book, box, bell, balloon

red: mop, mitten, map, mouse

blue: lemon, lock, lamp, lion

## Page 3

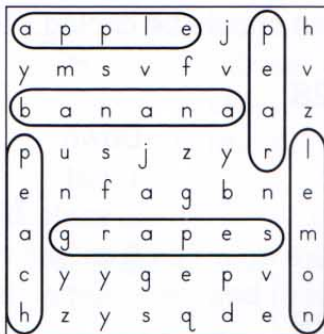

## Page 4 AT A "HOOT"EL!

## Page 5

cat	coat
log	drum
ball	a comb

## Page 6

pig-hill; crab-cap; mop-frog; sun-bug  
Bed should be circled.

## Page 7

Across	Down
1. pen	2. nest
4. sled	3. bell
5. jet	
6. leg	

## Page 8

The path should go through the desk, doll, dinosaur, duck, door, and deer.

## Page 9

yellow: ring, rake, rocket, rope, rainbow, rug

orange: web, wagon

red: hammer, horn, hat, hand

## Page 10

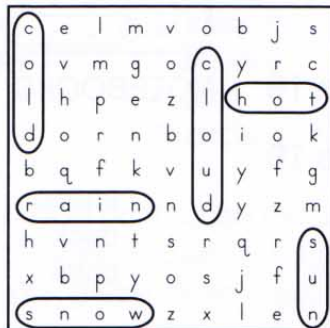

## Page 11 HOPSCOTCH

## Page 12

door	bird
corn	hand
glue	rug
dinner	

## Page 13

lamp-jeep; rug-flag; coat-tent; girl-bell  
Umbrella should be circled.

## Page 14

Across	Down
3. clock	1. doll
4. pot	2. top
5. log	3. cot

## Page 15

The path should go through the fire, fox, feather, football, fork, and fan.

## Page 16

yellow: fork, fan  
purple: saw, sock  
blue: corn, cake, carrot, cat, car, coat.



### Page 17

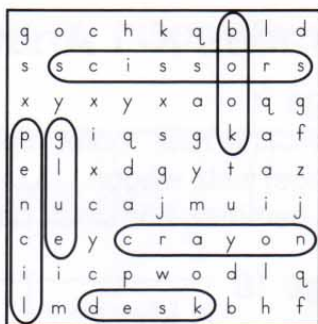

### Page 18 NOTEBOOKS

### Page 19

cow	sheep
pig	duck
turkey	chick

### Page 20

turtle-table; wagon-watch; box-book;  
zipper-zebra  
Coin should be circled.

### Page 21

Across	Down
1. duck	1. drum
3. bug	2. cub
5. mug	4. gum

### Page 22

The path should go through the bug,  
flag, dog, pig, and frog.

### Page 23

orange: net, nut, nest  
yellow: jelly, jet, jar  
blue: pig, pen, pot, pencil

### Page 24

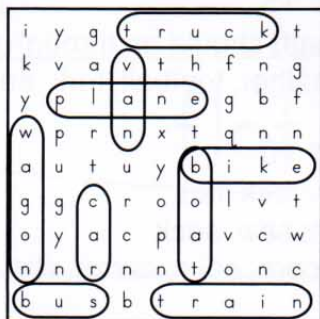

B

### Page 25 ON SILLY PADS!

### Page 26

vine	cape
bone	tube

cube-tube; tape-cape; cone-bone;  
nine-vine

### Page 27

horse-hammer; ring-rake; fish-fire;  
mitten-moon  
Doughnut should be circled.

### Page 28

Across	Down
1. ham	1. hat
2. stamp	2. sack
4. pan	3. map

### Page 29

The path should go through the bell,  
pencil, wheel, shell, snail, well, doll, and  
nail.

### Page 30

yellow: Pam, jam, swam, clam  
green: flat, cat  
blue: Dan, pan, plan, ran, van, can, tan,  
man

### Page 31

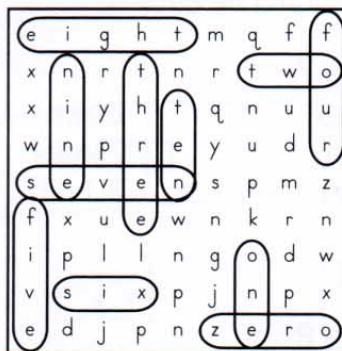

### Page 32 JELLY BEANS

### Page 33

star	mouse
bow	kite
girl	a towel

### Page 34

sock-saw; duck-dog; nest-nail; wagon-window  
Rainbow should be circled.

### Page 35

Across	Down
2. dog	1. mouse
4. turtle	3. cat
6. fish	5. rabbit

### Page 36

The path should go through the sun, corn, lion, lemon, can, and moon.

### Page 37

green: pin, tin, thin, chin  
brown: dig, pig, big  
yellow: sit, lit, it, split, knit, pit, hit, slit, bit, fit, quit

### Page 38

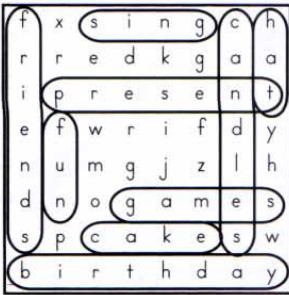

### Page 39 ON A "BUZZ"!

### Page 40

puppy	prize
hose	kite
cage	1. hose
2. prize	3. kite
4. cage	5. puppy

### Page 41

cup-cake; foot-ball; door-bell; doll-house  
1. football 2. cupcake  
3. dollhouse 4. doorbell

### Page 42

Across	Down
3. diamond	1. triangle
5. rectangle	2. square
	4. oval
	6. circle

### Page 43

The path should go through the pig, pear, pencil, pumpkin, pen, penguin, pot, paint, pie, pillow, peach, and peas.

### Page 44

blue: tape, ape, shape, grape  
yellow: bake, snake, shake, wake, fake, lake, make, take, rake  
red: same, came, name

### Page 45

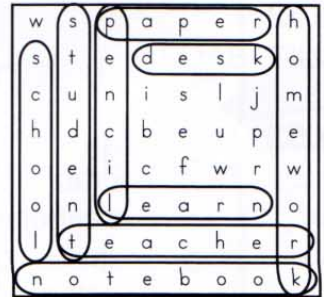

### Page 46 "QUACK"ERS!

### Page 47

happy	funny
sleepy	cute
noisy	pretty
neat	"pup"corn!

### Page 48

Across	Down
2. gift	1. kit
5. pin	2. grin
	3. fin
	4. lip

### Page 49

The path should go through the bear, pear, door, car, star, zipper, jar, chair, flower, hammer, feather, and deer.

### Page 50

The real compound words are cupcake, butterfly, doorbell, cowboy, teapot, snowman, and sailboat. The picture should be a heart.

### Page 51

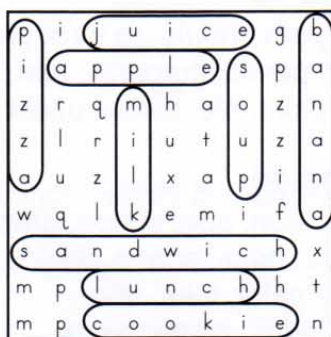

### Page 52

“BISCUIT”-BALL!

### Page 53

oyster	crab
lobster	seahorse
dolphin	gull
shark	octopus

### Page 54

The path should go through the kite, goat, bat, hat, net, cat, boat, gate, coat, pot, and boot.

### Page 55

Across	Down
3. purple	1. orange
4. green	2. blue
6. yellow	5. red

### Page 56

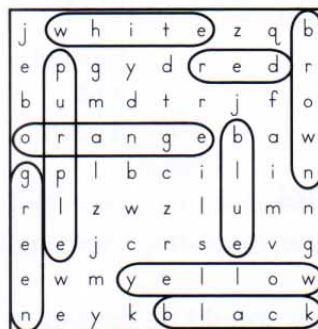

### Page 57

The path should go through the web, watch, walrus, wheel, watermelon, wig, well, whale, and window.

### Page 58

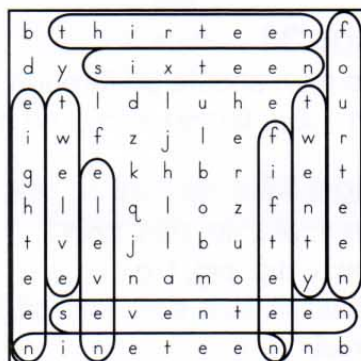

### Page 59

Across	Down
2. small	1. cold
3. down	2. stop
5. wet	4. new

### Page 60

Across	Down
1. legs	2. eyes
3. ears	4. hair
4. hands	
5. arms	



# Look What I Did!



Place a sticker in the box for each completed page.

page 1	page 2	page 3	page 4	page 5	page 6	page 7	page 8
page 9	page 10	page 11	page 12	page 13	page 14	page 15	page 16
page 17	page 18	page 19	page 20	page 21	page 22	page 23	page 24
page 25	page 26	page 27	page 28	page 29	page 30	page 31	page 32
page 33	page 34	page 35	page 36	page 37	page 38	page 39	page 40
page 41	page 42	page 43	page 44	page 45	page 46	page 47	page 48
page 49	page 50	page 51	page 52	page 53	page 54	page 55	page 56
page 57	page 58	page 59	page 60				





**140**  
Stickers!

**Carson-Dellosa's Home Workbooks are perfect for building basic skills! Educate and entertain young learners with age-appropriate activities, puzzles, and games. Great for extra practice at home or school and during travel or school breaks!**

## Puzzles & Games Included:

- Secret codes
- Word searches
- Word scrambles
- Crosswords
- ... and more!



**Carson-Dellosa**

Publishing Company, Inc.  
Greensboro, NC

ISBN 0-88724-723-7



5 0249



9 780887 247231



0 44222 14860 7

Printed in the USA